

GREAT PROSPECTS OPENED UP BY CORONATION TELEVISION

Television

and *SHORT-WAVE WORLD*

1/-
MONTHLY

JUNE, 1937

No. 112. Vol. x.

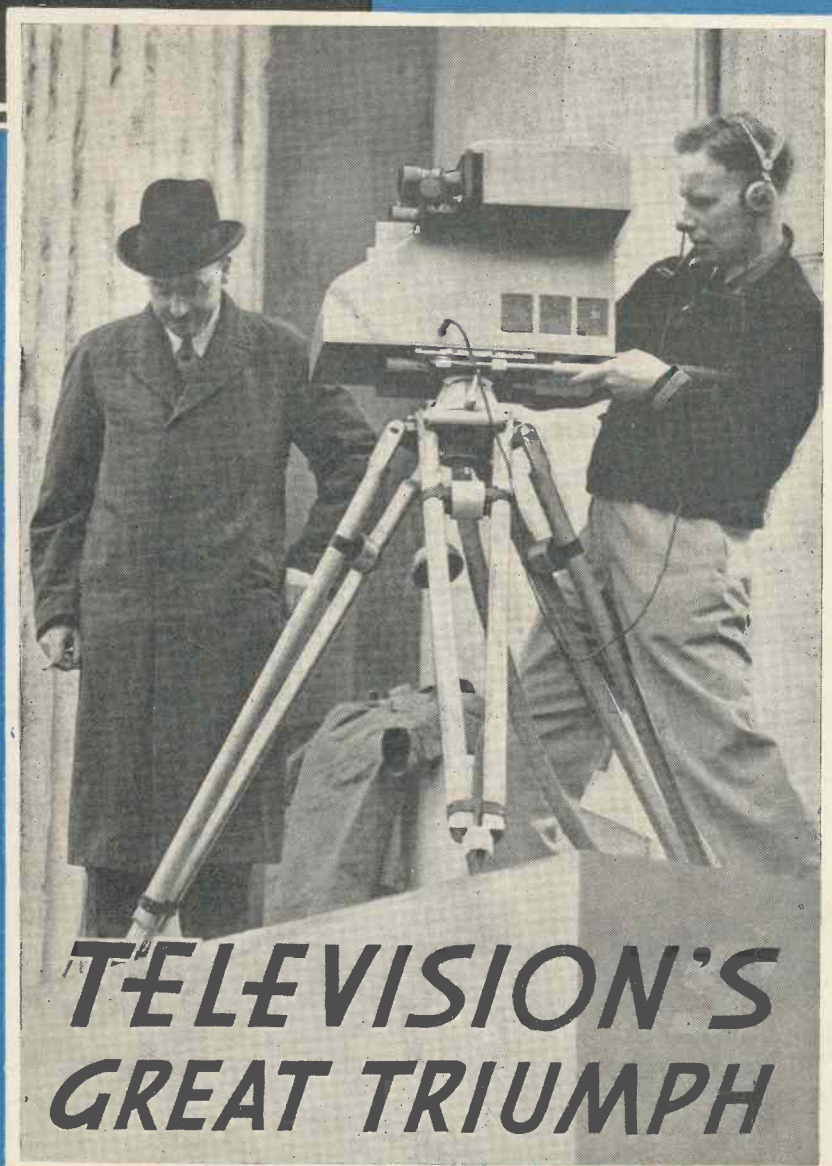

TELEVISION
CAMERA
EXPLAINED

MIHALY-TRAUB
SYSTEM

GLOW-GAP
DIVIDER

FREE TELEVISION
EXHIBITION

NEW OSRAM
PHOTO CELLS

SHORT-WAVE
AERIAL
EXPERIMENTS

SELF-
CONTAINED
SHORT-WAVE
RECEIVER

**TELEVISION'S
GREAT TRIUMPH**

BERNARD JONES PUBLICATIONS LTD.
CHANSITOR HOUSE, CHANCERY LANE
LONDON W.C.2.

THE FIRST TELEVISION JOURNAL IN THE WORLD

TELEVISION DEVELOPMENTS

A NEW LARGE DIAMETER TUBE FOR TELEVISION REPRODUCTION



**TYPE 12H
TUBE**

The Ediswan Type 12H tube has a screen diameter of 12" giving a television picture 10" x 7½" without distortion.

The screen is of special material giving a close approximation to a black-and-white picture.

Specification:

- Indirectly heated high vacuum tube.
- Heater Volts - - - 2.0
- 3rd Anode Volts - - - 6000
- 2nd Anode Volts - - - 1200
- 1st Anode Volts - - - 150-400
- Sensitivity (mm./V.) - - - 950/V*

*V = anode volts

List Price £15. 15. 0

We also supply
HIGH VACUUM RECTIFIERS
GAS-FILLED RELAYS
MERCURY VAPOUR RELAYS
for Television Scanning
circuits.

ENTIRELY BRITISH MADE

EDISWAN RADIO VALVES

THE EDISON SWAN ELECTRIC CO. LTD.  155 CHARING CROSS RD., LONDON, W.C.2

R.E.299

USED BY ALL GOVERNMENT DEPARTMENTS

TELEVISION

and SHORT-WAVE WORLD

Special Features

	PAGE
The Mihaly-Traub System	324
The Television Camera	329
C.R. Tube Television	330
The Glow-gap Divider	332
The First Real Television O.B.	335
The Television Exhibition	336
Construction of Acorn Valve Receiver for Vision Signals	340
Osram Secondary-emission Photo-cell Multi C.R. Tube Screen for Large Pictures	343
Guaranteed Receiver Circuit	345
Self-contained 3-valve Receiver	351
Programmes for Short-wave Listeners	356
6L6 60-watt Amplifier	360
Frequency Doubling Simply Explained	362
2-watt, 2-valve, 7-metre Receiver	363
Some Experiments with Aerials	365
An A.C.-D.C. Electron-coupled Oscil- lator	367
5- and 10-metre Reception	369

TELEVISION AND SHORT-WAVE WORLD

Proprietors :

BERNARD JONES PUBLICATIONS, LTD

Editor-in-Chief :

BERNARD E. JONES.

Editor :

H. CORBISHLEY.

*Editorial, Advertising and Publishing
Offices :*

Chansitor House, 38, Chancery Lane,
London, W.C.2.

Telephones : Holborn 6158, 6159

Telegrams : Beejapee, Holb., London.

Subscription Rates : Post paid to any
part of the world—3 months, 3/6 ;
6 months, 6/9; 12 months 13/6.

Published Monthly—1/- net.

(Last Wednesday in every month for
following month).

Contributions are invited and will be
promptly considered. Correspondence
should be addressed according to its
nature, to the Editor, the Advertisement
Manager, or the Publisher, "Tele-
vision and Short-wave World," Chansitor
House, Chancery Lane, London, W.C.2.

IMPORTANT

"Television and Short-wave World" is regis-
tered at the General Post Office, London, for
transmission to Canada and Newfoundland
by Magazine Post. Entered as Second-class
mail matter, Boston, Mass.

COMMENT OF THE MONTH

A Great Triumph

IT is impossible to over-emphasise the importance of the successful transmission of the Coronation procession. Undoubtedly it marks the commencement of a new era in television and indicates its true sphere of usefulness. Mr. Gerald Cock, the Television Director, was a true prophet when he said: "In my opinion, much of the fascination of television, and to a great extent its future, is bound up with actuality, a virtue which it alone possesses, and which the news reel, with its time-lag, misses." To those, who later in the day, saw a film of the procession, the truth of this was very apparent, for despite the obvious fact that the film was bound to be superior in technique, there was in the latter that lack of actuality which even with its shortcomings only television can give. There is that psychological difference in the knowledge that what is being seen is taking place at the very instant.

The possibilities which the success opens up are illimitable and it is to be hoped that the B.B.C. will make the very fullest use of them for it is to these outside broadcasts that the public will direct its attention. In television circles the phrase "Seeing the Derby" has become a cliché. It has provided an objective right throughout the course of television development and now we know that there is no obstacle or serious difficulty which need prevent this classic race being seen in the homes of scores of thousands of people. 1938 should most certainly see this dream of the television pioneers come true and in the meantime there are many events available, which though perhaps of lesser importance, will pave the way to this culminating triumph.

Post Office Help for Amateurs

ALTHOUGH the General Post Office have a monopoly on radio trans- mission and the issuing of licences to amateurs, it is not generally realised just how much assistance experimenters obtain from them. Rarely is an application for a transmitting permit rejected when genuine technical reasons are offered. Extensions to existing licences are also willingly given, providing a satisfactory explanation is supplied. Going even further in their help, the Post Office have arranged for amateur licence holders to have their permits extended after serving a probationary period so that they can use a higher power of up to 25 watts without giving any technical reasons for so doing. It can be taken for granted that any amateur station that has been licensed for six months or more can obtain a 25-watt permit. In the past any extension to licences had to be accompanied by a lengthy technical reason. However, this additional permit calls for an additional licence fee.

The Post Office also help amateurs in other ways. For example, during the summer months when a certain amount of work is done in the open, it stands to reason that amateurs would need some facilities for obtaining a temporary portable licence. It has now been arranged that any amateur can, by applying, be granted a permit to operate a 5-metre portable within 10 miles of any given Post Office.

THE MIHALY- TRAUB SYSTEM



These two photographs show the demonstration theatre and the radio laboratory of The International Television Corporation. In the foreground of the upper picture can be seen the first model of the home-type receiver.

NEW LABORATORIES DEVELOPMENT OF HOME RECEIVERS HOW THE SYSTEM FUNCTIONS

FROM time to time, ever since the Mihaly system of mechanical-optical television was first introduced, we have given details of the progress and the modifications that have been made in the original type of apparatus. These details were entirely concerned with laboratory models in the first case of the actual Mihaly system and latterly of the Mihaly-Traub system, which, though based on the former, now differs very considerably in several respects.

Originally this system was developed for 30 lines, and then later 90 and 120 lines, and each increase in definition made a great deal of intensive research work necessary both with regard to the scanning and optical equipment and the associated radio equipment. After successful results had been obtained on 180 lines, the next step would have appeared to be 240 lines, but a decision was made to tackle right away the more difficult problem of 405 lines. That this decision was a wise one is now apparent, for it has avoided the necessity of a further period of experiment and research.

Concurrent with this research for the provision of a much higher degree of definition, the problem of incorporating the laboratory apparatus in a commercial design has been tackled, and though the final design has not yet been reached, it has taken sufficient shape to indicate what form the commercial Mihaly-Traub receiver will take. Two receiver models are shown in one of the photographs on this page; one has a screen measuring 12 ins. by 15 ins., and the other 13 ins. by 16 ins., and as will be seen all the apparatus is con-

tained in cabinets which are approximately the same size as are used for housing cathode-ray receivers.

New Laboratories

In order that the development of the commercial receiver could proceed more conveniently it has been

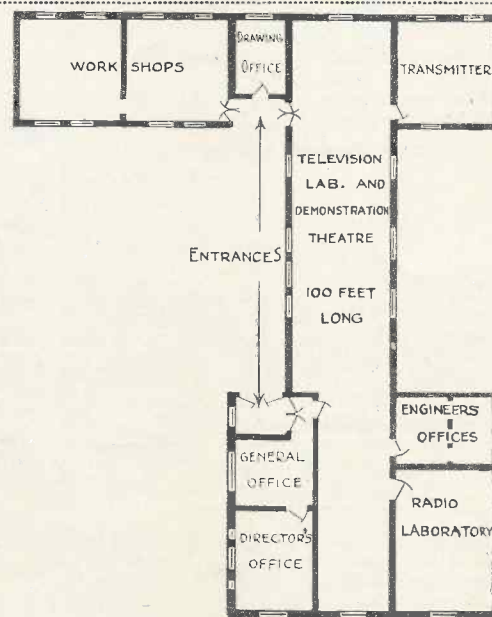

Plan showing the arrangement of the International Television Corporation's laboratories.

found necessary to equip new and larger laboratories. These now occupy the whole of the upper floor of Maidstone House, Berners Street, London, W., and as will be seen from the plan on page 322 comprise a demonstration theatre and television laboratory, mechanical workshop, radio laboratory, transmitting room and the usual offices. The mechanical workshop is equipped with machine tools so that all the parts required for development can be made on the spot. The demonstration theatre is 100 feet long and capable of holding a large screen as one objective of The International Television Corporation is the large-screen television pic-

ture suitable for large halls and cinema theatres, etc.

Further developments in the case of the home-size receiver are now mostly concerned with details and simplification so that it can be placed in the hands of the public with the certainty that it will work reliably and with no more skilled attention than the average domestic electrical device requires.

In the following pages a technical description of the Mihaly-Traub system is given, the information being based upon a lecture given by Mr. M. J. Goddard, one of the research engineers of The International Television Corporation, Ltd., before The Television Society.

HOW THE MIHALY-TRAUB SYSTEM WORKS

THE Mihaly-Traub system is a mechanical-optical system employing a combination of stationary and moving mirrors as a means of scanning television pictures. It is applicable to both transmitters and receivers, but in the following its application to reception only will be dealt with. For this system a light

adjusting the 100 mirrors of the ring to exactly the right position both laterally and vertically. This difficulty becomes still greater with higher numbers of lines, as also does the excessive size of the ring.

The Traub Modification

Traub has devised a system which reduced the difficulty of adjustment and increased the optical efficiency about 64 times, compared with Mihaly's arrangement. He replaced the Mihaly rotating mirror by a rotating mirror-drum, but a drum having comparatively few sides. Instead of the complete ring of stationary mirrors he used only a portion of the ring. Thus for a 100-line picture, a rotating drum with five mirrors and a ring of 20 stationary mirrors could be employed, as shown by Fig. 2.

The overall linear size of the system need only be about one-eighth that of Mihaly's system, or if the overall linear size employed is the same as in Mihaly's system, the area of the ring mirrors and therefore the illumination of the screen is increased 64 times.

In order to give a uniform scan all across the line,

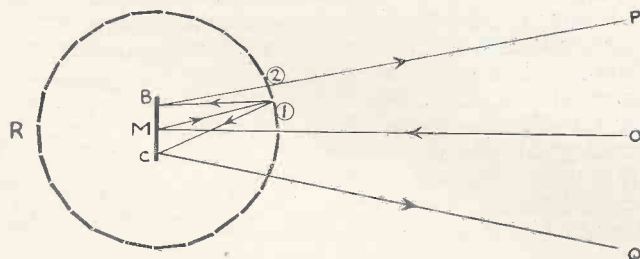

Fig. 1. Diagram showing the principle of the original Mihaly receiver.

source in the form of some electric lamp is employed, and the light from this is passed through a "light-valve" to which the signals received from the broadcast waves are applied in such a way that the intensity of the light leaving the cell is proportional to the strength of the signal received; the light is then made to traverse the screen in the form of a moving spot by means of the combination of stationary and moving mirrors.

The Original Receiver

The system was originally developed by Mihaly, but as will be seen it has undergone considerable modification since. Mihaly used a single rotating mirror M (silvered on both sides) (Fig. 1), and made the "drum" in the form of the stationary ring of mirrors R. Light incident from O strikes the mirror M, and is reflected to a given part of the mirror ring determined by the instantaneous position of M. Suppose at the instant considered it is reflected to the junction of mirrors 1 and 2. The light from 1 is reflected to B on the mirror M, and thence to P. That from 2 is reflected to C, and thence to Q. As M rotates, the light is scanned just as with a rotating drum, while the mirrors of R must now be tilted to produce the necessary relative displacement of successive lines (i.e., the so-called "frame-scan").

One difficulty with this original system was that of

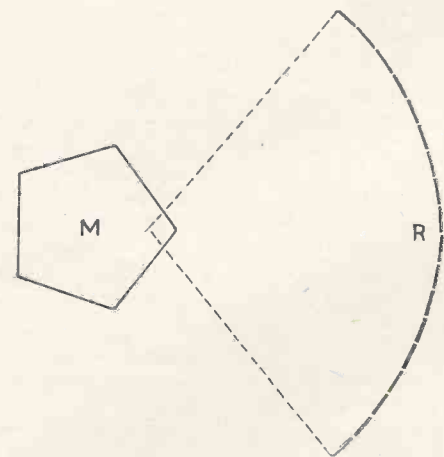

Fig. 2. Mirror combination for 100-line scanning.

the drum mirrors must be twice as large as the ring-mirrors. Thus in the 100-line system the drum mirrors would be 9.2 cm. wide, giving a drum about 15 cm. in diameter. The drum rotates once per picture; i.e., the speed of rotation is 1,500 r.p.m. This is not

INTRODUCTION OF FRAMING DRUM

impossible, and there are fewer components to adjust than in the Mihaly system, while the ring is smaller. (This system is essentially the prototype of the present Mihaly-Traub scanner.)

The Framing Drum

A great advance was made when a crossed drum was introduced to bring about the frame scan in place of the tilting of the mirrors of the ring and drum. The great advantage of this was that the product of the numbers of ring-mirrors and drum mirrors need no longer be equal to the number of lines. The product

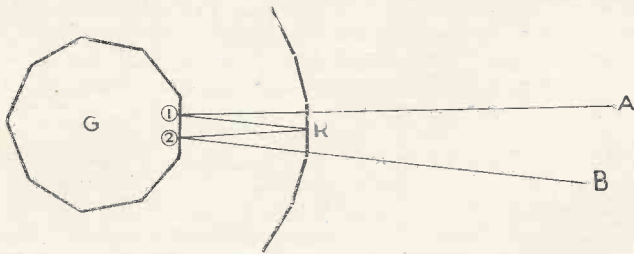

Fig. 3. Scanner for 405-line reception with path of light rays indicated.

can be decreased in a certain ratio, provided that the speed of rotation of the drum is increased in the same ratio. The diameter of the drum is now small (about 3 cm.); it can be made as a solid piece of glass, so that, once accurately made, it needs no adjustment.

A picture of 100 lines with satisfactory brightness can be obtained with quite a small scanning system. A tolerably satisfactory picture of 180-lines was, in fact, obtained in this way at the research laboratories of the International Television Corporation, but the brightness of the picture was less than the minimum desirable. The scanner employed was small, and the brightness could have been made sufficient by increasing the size of the scanner, but it was clear that the increase in size necessary for higher numbers of lines would still be prohibitive, so that it was necessary to have recourse to further improvements.

A New Light Valve

In the systems so far considered the solid angle of the cone of light converging on the screen, and therefore the illumination of the screen, is directly proportional to the size of scanner employed. If, however, the image of the source of light could be focused at or near the scanner, this would no longer be the case.

If an image is formed on any object, and an image of this is formed on a screen, no motion of that object will cause any motion of the image on the screen. Thus, if an image of the source is projected on to the scanner, and an image of this is projected on to the screen, no scanning motion will be produced on the screen. However, the introduction of a new light-valve obviated the necessity of forming an image of the source of light on the screen. It was then possible to focus an image of the source at or near the high-speed scanner, which could then be made small without reducing the illumination of the screen, and therefore, as far as the dimensions of the high-speed

scanner were concerned, a picture of adequate brightness could be obtained with any number of lines. With this system it has been found possible to construct a 405-line receiver giving a picture of adequate brightness.

The choice of 405-lines for the picture is very fortunate from the point of view of the Mihaly-Traub scanner. The combination of a nine-sided drum with five stationary ring-mirrors has been found very convenient, and for this combination the drum has to rotate exactly nine times per picture to give 405 lines, since $405 = 9 \times 5 \times 9$.

We may at the present stage pause to consider the advantage of this system over that employing two simple drums. It is clear that the Mihaly-Traub scanner could be replaced by a simple drum. However, the speed of rotation of the nine-sided drum in the Mihaly-Traub 405-line receiver is $9 \times 1,500$ or 13,500 r.p.m., while that of a simple nine-sided drum would be $45 \times 1,500$ or 67,500 r.p.m. Alternatively a simple drum rotating at 13,500 r.p.m. would require 45 faces. Thus for a given drum, the Mihaly-Traub system reduces the necessary speed of rotation, while for a given speed of rotation it reduces the number of faces required on the drum, and therefore the diameter of the drum for a given size of face. Furthermore the scanning angle for a 45-sided drum would only be half that of a corresponding Mihaly-Traub scanner, so that the distance from the scanner to the screen would be approximately doubled for the same picture size, thereby necessitating a much bigger cabinet.

Receiver Design

We may now consider the actual form of the lay-out of the optical system which is employed in Mihaly-

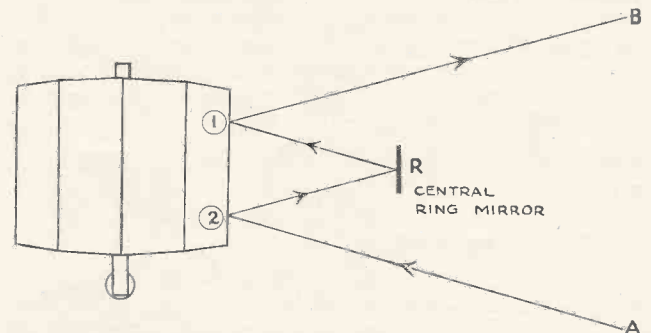

Fig. 4. Plan view of scanner showing path of light rays.

Traub receivers. The basic feature of the system is, of course, the high-speed scanner. This, as we have seen, consists, in modern 405-line receivers of a nine-sided polygon with five stationary ring-mirrors, as shown by Fig. 3. The light is incident from A on the polygon at 1. After reflection from a ring-mirror at R, it is reflected again at 2 from the polygon to B. Clearly if incident normally on the polygon, it would foul the ring-mirrors. It must, therefore, enter the system at an angle to the normal in the plane normal to the scan. It therefore describes a sort of W-shaped path through the system, as shown in Fig. 4.

INCIDENCE AND REFLECTION ANGLES

The angle through the system depends on the size of the cone of light which it is desired to pass through, which in turn depends on the angle which the lens immediately before the slow drum subtends at the high-speed scanner. For home receivers it is usually found that an angle of about 30° through the system must be used, i.e., the semi-angle of the W must be 30° .

The next essential part of the system is the slow drum. In this case the light has already started scanning in the plane normal to the scan of the drum, so it is not practicable to feed the light on to the drum at an angle in this plane. It must therefore fall obliquely in the plane of scanning of the drum.

The more oblique the incidence, the smaller will be the angle of convergence of the rays for a given size of drum-mirror. Therefore the direction of incidence is made as near radial as possible consistent with keeping the projection lens L (Fig. 5) clear of the reflected rays. In practice it is seldom found possible to reduce the angle of incidence below $37\frac{1}{2}^\circ$ to the radial direction of the drum.

The screen should be vertical, so the mean direction of the rays reflected from the slow drum should be horizontal. In designs, where it is possible, the axis of the high-speed scanner is made horizontal, as shown in Fig. 6, which gives an idea of the general arrangement. This would bring the light valve to V^1 and the source to S^1 . It is not practicable, however, to have any part of the system in front of the vertical plane of the screen, so a reflector is placed at Q, bringing the light-valve to V and the source to S. This brings the whole system to a compact form, which can conveniently be packed into a cabinet, as shown in the diagram. The mirror at Q may usefully be made concave, so that it replaces one of the lenses of the optical system.

There are certain other aspects of the problem of securing a serviceable lay-out which may be mentioned. It is desirable, from the point of view of the optical

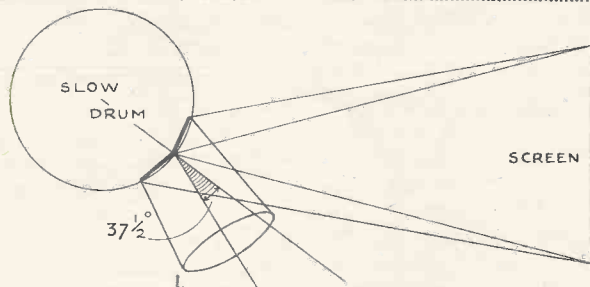

Fig. 5. Light incidence and reflection angles on slow drum.

efficiency of the slow drum, to make the angle of incidence of the light falling on the slow drum as small as possible consistent with the condition that the final projection lens does not foul the output beam. However, if the distance between the high-speed scanner and the slow drum is very large, the high-speed scanner may then fall in front of the plane of the screen. This would mean that the screen would have to be set back from the front of the receiver. From the point of view of the general appearance of the receiver this is undesirable, unless the amount by which the screen is set back is quite small. To overcome this difficulty, the angle of incidence to the slow drum may be increased, or the

distance from the slow drum to the screen may be increased (by increasing the number of mirrors on the drum), thereby throwing the screen further forward relative to the high-speed scanner.

Another factor which must be considered in deciding the position of the slow drum is the effect of this on the

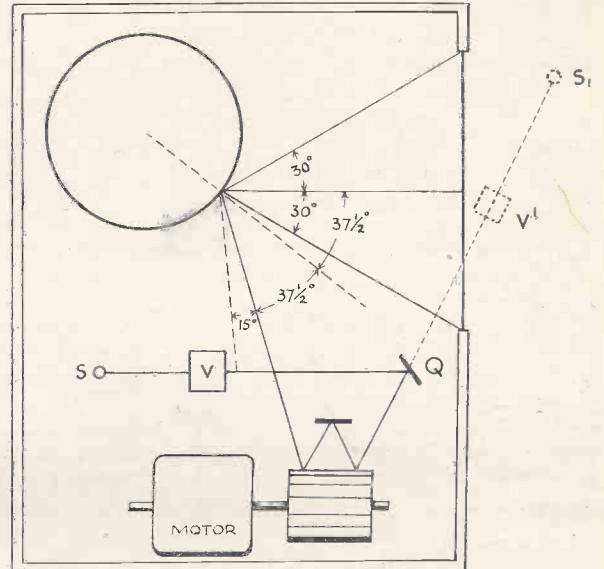

Fig. 6. Schematic arrangement of complete scanning gear.

external shape of the receiver. If the drum is brought further from the screen, then the depth from back to front of the set is increased, but the height is reduced, as the distance from the high-speed scanner to the drum is reduced. If the receiver is to be of the "portable" type, to stand on the table, then its height must not be too great. If, however, it is to be of the upright type to stand on the floor, then the available height of the cabinet will in all probability be ample to accommodate any optical system which is likely to be employed, so that the drum can be brought as near as possible to the screen to reduce the depth of the receiver from back to front.

Another factor which we have not so far considered in any detail is the scanning combination of the high-speed scanner. This determines the scanning angle in the plane of line-scanning. This angle must be made small enough to present a picture to the observer having tolerably uniform brightness all across. On the other hand if the angle is decreased too far, the distance from the scanner to the screen becomes excessive, and the overall size of the set is then increased. If the scanning angle of the high-speed scanner is increased, while that of the slow drum remains small, the distance between the two scanners may become insufficient. This is not, however, likely to happen in practice, as the scanning angle of the slow drum is kept as large as possible to give high optical efficiency, while that of the high-speed scanner has no effect on the optical efficiency, so it is kept as low as convenient consistent with a reasonably compact lay-out.

The angle at which the rays pass through the high-speed scanner can be varied. In general it is kept as small as possible consistent with the condition that the light does not foul the ring-mirrors, in order to reduce

SCANNER DESIGN

the axial length of the drum as far as possible. This angle, however, has an effect on the scanning angle, and if it is necessary to reduce the scanning angle

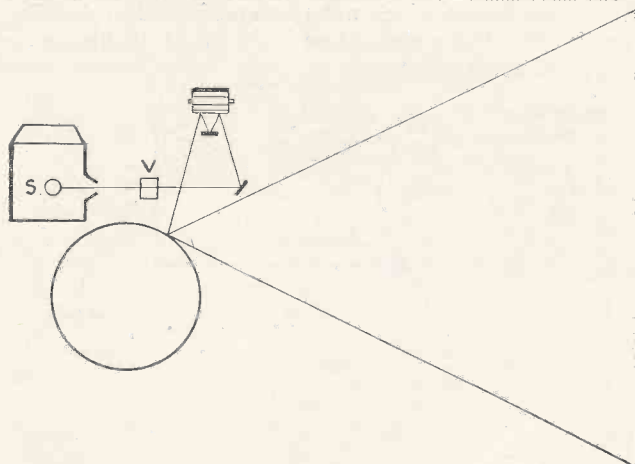

Fig. 7. Arrangement of scanners in large-screen receivers.

slightly, it can be done by increasing the angle through the high-speed scanner.

Large-screen Receivers

The lay-out of large-screen receivers is somewhat different. Here the slow drum is large, so it is kept as low down as possible. Accordingly light is reflected off the top of the drum to the screen so that the high-speed scanner is above the slow drum (see Fig. 7). Otherwise there is a close similarity between the systems for large and small screen work.

Scanner Design

It will be of interest to describe the design of the Mihaly-Traub scanner itself. For definiteness let us assume a drum of nine faces with five stationary ring mirrors. We will also assume, for simplicity, that the light passing through the system is parallel. The light incident on the drum must be just sufficient to cover two faces in the symmetrical position (Fig. 8). The centre of the circle on which the ring-mirrors lie is about half-way between the centre and the circumference of the drum. (The arc formed by the ring-mirrors subtends an angle at the centre of the ring equal to twice the angle between consecutive faces of the drum (80° in the case which we have assumed). The radius of the ring is such that the light reflected from the ring-mirrors always falls on the operative face of the drum. If the ring is too large compared with the drum, this is not the case, while if it is too small the dimensions of the reflected cone of light are small compared with the drum and the incident cone of light, so that the system is uneconomical. The optimum radius for the ring is found by a graphical construction. It is such that the ring mirrors are about half the width of the faces of the drum.

For the light source, a Phillip's exciter lamp is usually employed for home receivers—either the 32-watt, having a filament 0.6 mm. wide or the 50-watt having a filament 1.5 mm. wide. Each lamp has a

filament about 5 mm. long. For larger receivers, arc lamps of convenient types are employed, depending on the screen size required.

All lenses are designed to be as free as possible from spherical aberration. Other lens aberrations are much less serious and can usually be ignored. Achromatic lenses are sometimes employed, but not so much because it is important to eliminate chromatic aberration but because these lenses can be more completely corrected for spherical aberration than non-achromatic lenses. Some special lenses have been designed with this in view. In particular, a lens is required on either side of the light valve, and for these special lenses have been designed which can be cemented to the outside of the cell, thus reducing the reflection losses, and yet giving almost complete freedom from spherical aberration.

By means of the Mihaly-Traub system, it is possible to design home receivers for 405-lines, interlaced scanning, giving pictures of adequate brightness up to 20 inches wide. Such models have already been constructed in the laboratories of the International Television Corporation, Ltd. Moreover, big screen projectors giving 405-line pictures 10 feet wide have been

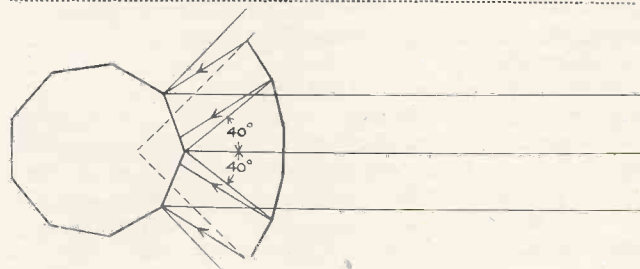

Fig. 8. Light incidence and reflection between ring mirrors and high-speed drum.

designed. High numbers of lines present no serious obstacles, as the system is capable of dealing with a definition up to 1,000 lines quite comfortably.

Delayed Switching

The problem in television and other high-voltage amplifiers is how to heat the filaments of the mercury vapour rectifying valves before the high voltage is applied.

As a general rule a thermal delay switch is included which can be of the valve or semi-mechanical types. In either case an expense is incurred which most television constructors feel to be rather unnecessary.

A scheme which transmitting amateurs use with success seems to be applicable to television amplifiers. A wide contact switch is connected in series with the centre tap to the H.T. secondary on the mains transformer. When this switch is open no H.T. is applied to the anode of the rectifying valve, but when the contact is closed full H.T. is applied.

As one side of the switch is at earth potential there is no danger of shock and the valve filaments can be switched on and after 60 seconds or so H.T. applied by making the contacts in the switch in the H.T. centre tap return lead. This scheme will save another half a guinea when building high-voltage equipment.

THE TELEVISION CAMERA

A SIMPLE EXPLANATION OF ITS WORKING PRINCIPLES, CAPABILITIES AND LIMITATIONS

THE following notes will give readers some idea how photographic and televisionic cameras compare.

The knowledge that the word "camera" means "a chamber" will hardly help us to picture in our minds the various classes of modern apparatus which are now used. It was in the sixteenth century that the Italian, Battista Porta, discovered that by covering up a window with a shutter with a very small hole in it, that a picture of the scene outside appeared, upside down, on the wall opposite the window. The size of the hole is important. The smaller the hole, the clearer or sharper the picture, though at the same time, duller or less bright.

The next step in camera development was to use a glass lens instead of the small hole, and so was developed the "camera obscura." This form of camera consisted in its most developed form of a lens L (Fig. 1), built in a sort of revolving turret head roof. Light from the lens was reflected by the mirrors M, generally at an angle of 45°, so as to throw an image on to the top of a white table, which was placed in a darkened room. The result of all this was that an observer inside the room, could see a picture of the outside

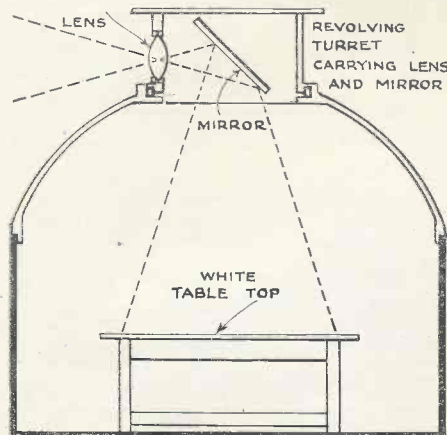
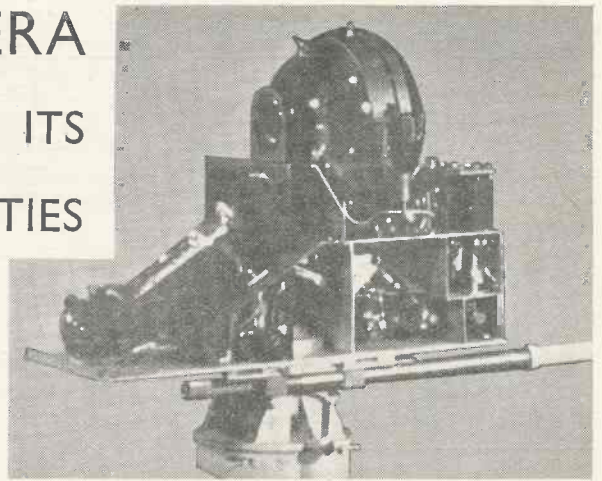

Fig. 1. Schematic diagram of camera obscura.

world, without himself being seen. The modern form of such an arrangement is the periscope.

The camera obscura existed for about a century before means were found of recording the images produced other than by drawing them in, a method of which many well-known painters of the times were accused of. In 1838, two Frenchmen produced the daguerreotype system by which optical images were recorded by the action of light, and this was followed by important improvements, resulting in photographs



The Marconi-E.M.I. television camera with the case removed.

on paper by Fox Talbot. Advance after this was rapid, though more in the preparation of sensitive materials, than actual cameras, F/8 being a fast lens for many years, which, employed with slow plate emulsions, necessitated long exposures, and therefore the first photographic cameras were those of the "stand" or "field" type.

Let us now take a big jump to the latest form of camera—that of television. Painted in a naval grey, on a rather massive stand, they look most imposing. Compared with the film camera the television camera is singularly free from external fittings, even to the lack of the lens hood.

The Lens

As the lens is the first necessity of all cameras, we will consider it first. The television camera lens is a 6.5-in. focus, working at F/3, and is mounted, as in a stand camera, on a vertical panel, which is moved in and out for focusing by the usual rack and pinion mechanism. A rising and falling front is not fitted. As the camera does not fold up, the bellows are only just sufficient to take up the necessary movement for focusing, it being, of course, absolutely necessary to have as much screening, in the radio sense as possible. In place of the film or plate is the photo-electric mosaic, which is enclosed in an evacuated glass vessel, in the scale of which, at the appropriate place is an optical flat, which is skilfully fused into the bulb, so as not to affect the optical image thrown by the lens on to the mosaic. Included in the evacuated bulb are the necessary electrodes to produce a focused electronic beam which scans the mosaic, the actual scanning forces being magnetic and produced by electro-magnetic coils external to the glass chamber. Below, and suitably shielded in small compartments are the various thermionic valves, which form the first part of the complex electrical chain.

Returning to the lens, many people have expressed some surprise at the relatively small F number, compared with some modern lenses. Actually the F/1.9 class of lens is only commercially used in the so termed "miniature" camera and cinematograph cameras, where the covering area, that is to say the image on the plate, is small.

Unfortunately, at present it is not possible to use a

DEPTH OF FOCUS IN TELEVISION PICTURES

mosaic of small dimensions, the reason being that an electron beam cannot be focused down to a sufficiently small area, though the present mosaic is sufficiently fine in the "grain" sense. From the photographic point of view, a small mosaic would greatly improve results, owing to the greater depth of focus obtainable with lenses of less covering power than that at present used.

Focal Depth

In practice a lens of $F/3$ of 6.5-in. focal length is in many people's opinion too large an aperture to give adequate depth of focus. As was recently pointed out

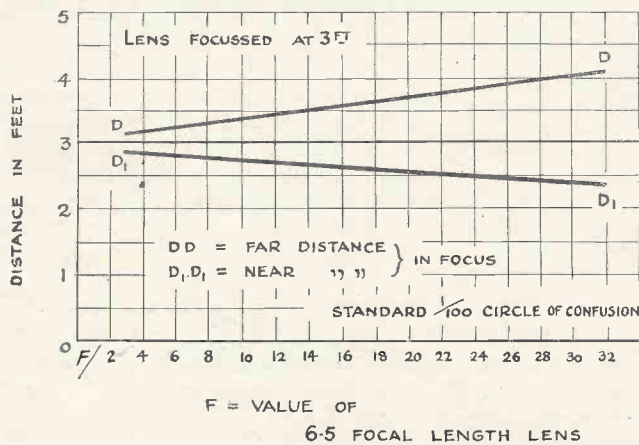

Fig. 2a. Graph showing depths of focus for different apertures.

in TELEVISION AND SHORT-WAVE WORLD, in the case of an object being focused 3 ft. away, then anything nearer than 2 ft. 11.5 ins. or further than 3 ft. 0.5 in. is out of focus, and even at 15 ft. there is only 22.25 ins. and 26.5 ins. latitude. It is interesting to note how the depth of focus would be improved if the usual cinema lens of 2 ins. focus could be used. In the case of an object 3 ft. away it would be sharp, as near as 2 ft. 4 ins. and as far as 4 ft., which means that one lens has a focal depth of 1 in. and the other 20 ins. focused on a given point. The advantage is, of course, proportional at all other distances. Figs. 2a and b show this depth of focus business graphically, both for depth at a given aperture (Fig. 2a), but different focal lengths, and different apertures for a given focal length (Fig. 2b). It will be seen that to get the same depth of focus at, say, 3 ft. the 6.5-in. lens must be stopped down to $F/32$ to equal the cinema 2-in. focus, and, of course, the 6.5-in. lens would be some 125 times slower.

Actually, television systems have not quite the same degree of sharpness as photography and as a result, the depth of focus problem does not appear quite as bad as one would expect. There seems little hope of improvement in this depth of focus problem, other than the increase of light in the studio and stopping down the lens. While this would certainly improve conditions for the lookers-in, the health and comfort of those in the studio would suffer.

There is a good deal of comment in some quarters as to this lack of depth of focus in television pictures, this as we have shown, must be so for the present, though

no doubt it will be overcome in time. The defect at present is often exaggerated by the wrong placing of artists for the existing limitations of the system.

View Finders

Of paramount importance in all cameras are the methods available for focusing and composing the scene to be recorded. Obviously, the best method is to be able to inspect the actual image thrown on the plate or film, or the substitute in the form of a ground glass plate. All photographic cameras of the more serious type are so constructed. In modern cinematograph cameras there are ingenious devices by which the operator can see the image on the actual film, while the camera is in operation. They are also fitted with a duplicated lens system and ground glass screen, the lens being optically matched with that of the taking lens to which it is mechanically geared. In the case of the duplicated lens system of viewfinder, the problem of parallax has to be overcome. In cinema and miniature cameras this is easily corrected, as the original error is not very great owing to the actual physical size of the lenses, and the areas they have to cover.

In the case of the television camera, the problem becomes somewhat more acute, owing to the large size of the lenses and areas covered. The type of viewfinder used in the television camera is somewhat similar to that of the cinema camera. A secondary lens is used which by a system of reflections projects the image on a ground glass, suitably hooded, at the side of the camera. The arrangement is shown diagrammatically in Fig. 3. It will be observed that the two mirrors and the lens are racked in and out with the taking lens, thus enabling focusing and composing to be carried out.

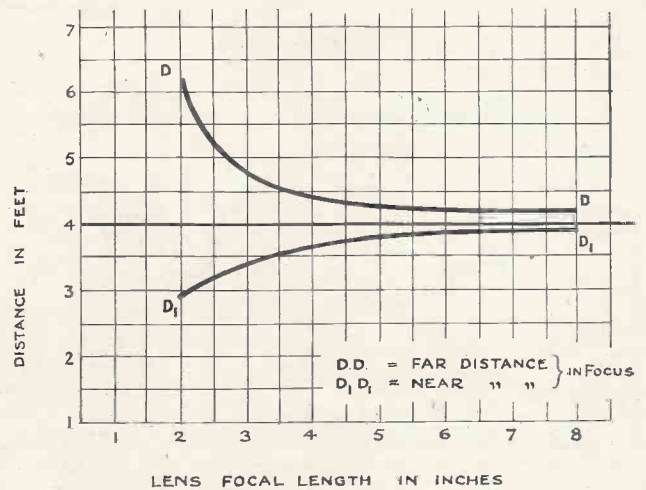

Fig. 2b. Graph showing depths of focus of lenses of different focal lengths. All lenses working at $F/3$ focused on a point 4 ft. distant. Standard $1/100$ in. circle of confusion.

It is to be expected that certain focusing errors are unavoidable when working at close range, owing to the slightly different distances of the object to the two lenses.

A very important point about the design of the focusing and composing devices on a television camera are

TELEVISION AND CINEMA CAMERA COMPARISONS

that they have to be in operation for much longer periods of time than the photographic prototypes. Viewfinders of cinema cameras are nearly always inspected by one eye through an eye piece, which for periods of more than a couple of minutes becomes somewhat of a strain. Luckily, in the making of films, very few "takes" are for more than three minutes, and most far less. The television camera, however, is constantly in use for periods of twenty-five minutes or even more at a time, rapidly going from near and long "shots" many times, and for this reason the focusing and composing device must have as bright a viewing screen as possible.

The fact that the television camera is instantaneous to our slow senses obviously offsets some of its disadvantages. The result is seen at once, though not by the camera operator, and he must therefore be given instructions by phone from technicians and producers, which usually are of great assistance, especially in following the action of a complicated play.

Four cameras are used at Alexandra Palace, three on stands and one on a "dolly" truck. The latter is a small truck on which the camera is mounted, fitted with pneumatic tyres and pushed about the studio by manpower, the camera-man, of course, travelling on the truck.

So much for the mechanical-optical side of the television camera of to-day. In the future, anything may

happen. No doubt the time will come when robot-like cameras will go through their evolutions controlled entirely from some master control room, the studio as a whole being watched by a master camera.

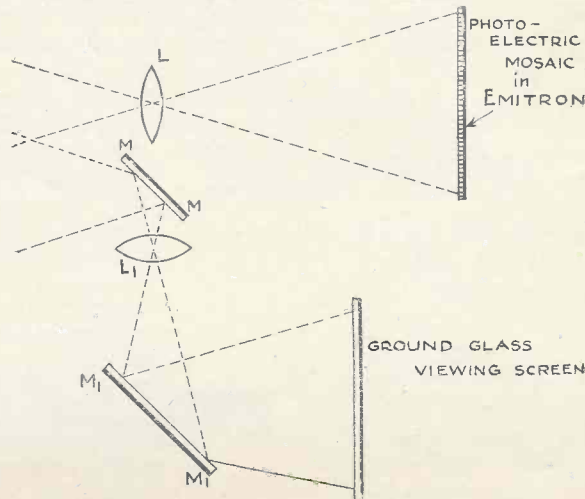

Fig. 3. Optical system of television camera. L, Lens projecting image on mosaic. Li, Lens projecting image on view finder ground-glass. MM, Mirror reflecting light from scene to lens Li. M, M, Mirror reflecting light from Li to ground glass screen. L, Li, MM and M, M, are all mechanically coupled.

THE FIRST CINEMA INSTALLATION

TO the management of The Odeon Cinema, Southgate, London, N., belongs the credit of being the first to instal a television receiver in the foyer of the cinema.

The event is of special interest for as Sir Michael Bruce, Bart., who represented the Odeon company said, the belief of the management is that television and the cinema will be

allies rather than rivals, an opinion which, coming from such powerful cinema interests, is of importance.

The inauguration ceremony was charmingly performed by Miss Anne Grey, the well-known film star, who wished the Odeon Company success in this new venture. An influential gathering representing film interests and well-known local guests including the Mayor of Southgate, Ald. H. F. Wauthier was present.

The object of the installation, which it is understood may be the forerunner of others is to provide entertainment for visitors waiting in the foyer. In this respect it has been entirely successful, and on Coronation Day a hundred special visitors were present who were loud in their praise of this latest cinema innovation.

No less than 32 cyclists will start on a 17½-mile road race in front of the television cameras on May 29. Some famous cyclists will take part, including at least three Olympic champions in J. G. Bone (Glasgow Wheelers), H. H. Hill (Sheffield Phoenix), and A. Bevan (Fountain C.C.). The circuit takes approximately 4 minutes to ride and it is hoped to televise the start and the finish of the first round.



The opening ceremony at the Odeon Theatre, Southgate. From left to right, the Mayoress, Mr. Elliott, the manager, Miss Anne Grey, the film star, the Mayor of Southgate and Lady Bruce.

THE GLOW-GAP DIVIDER

By J. H. Reyner, B.Sc., A.M.I.E.E.

Interesting details of a gas-discharge tube that maintains a steady voltage irrespective of current variation.

FIVE years ago the writer brought back from the Leipzig Fair an early sample of the glow-gap divider—an arrangement which was claimed to maintain the output voltage of a mains unit constant within

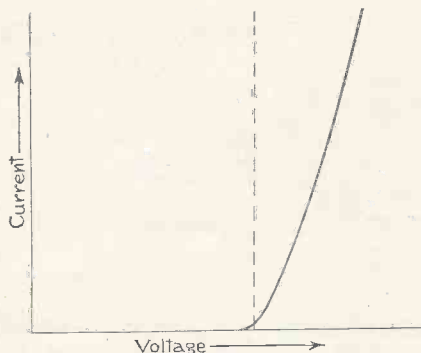

Fig. 1—Characteristics of neon Lamp.

close limits irrespective of current, and furthermore to provide tapings at suitable points without the aid of any external potentiometer network.

On test in the laboratory the device fulfilled these claims in a surprising manner, and it has in fact been in use ever since. This form of divider is available in this country. It is known as the Stabilovolt and is marketed by Marconi's Wireless Telegraph Co., Ltd., in various sizes

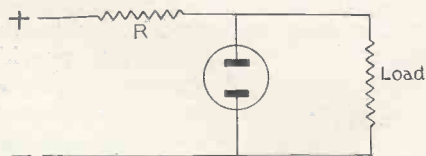

Fig. 2—Simple regulator circuit.

covering a wide range of current and voltage.

The inherent regulation of a neon lamp is well known. Fig. 1 shows the characteristics. No current at all will flow until the voltage across the lamp reaches a certain minimum value sufficient to cause ionisation of the gas. Once this happens the free electrons liberated by the electric field collide with further molecules of gas from which they liberate further elec-

trons and thus by a cumulative process a large current rapidly builds up. It is in fact necessary to include a series resistance to limit the current to a safe value, as otherwise the tube may be destroyed.

It will be clear that although the D.C. resistance of the tube may be somewhat high due to the high initial striking voltage required, the A.C. resistance is very low, for a surprisingly small increase in the applied voltage causes a rapid increase in the ionisation and the current grows considerably. In fact, the device acts like a condenser of very large capacity and may be used as such.

Fig. 2 shows a simple circuit. Voltage is fed to the tube through a suitable limiting resistance, while across the tube is connected the load. The current therefore divides partly through the tube and partly through the load. If the load resistance changes taking, say, a little more current, the voltage on the tube will be reduced because of the increased voltage drop on the series resistance R. But we have seen that a very small change in the voltage on the tube causes a large change in current and actually the tube current will fall off to an extent which allows the voltage across it to recover practically to the original value.

Now by proper design and the use of the correct mixture of gases at the right pressure the regulation obtained by this means can be made extraordinarily close, something in the neighbourhood of one or two per cent. drop only between zero and full load. But the Marconi Stabilovolt goes farther than this. It is possible by introducing additional electrodes between the anode and cathode of the tube to tap off voltage at intermediate

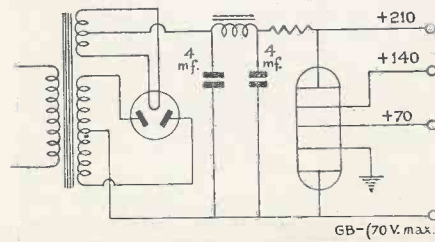

Fig. 4—Eliminator circuit with Stabilovolt control.

points. The voltage on each tap is dependent upon the ionisation potential which, in turn, is dependent upon the distance between the various elec-

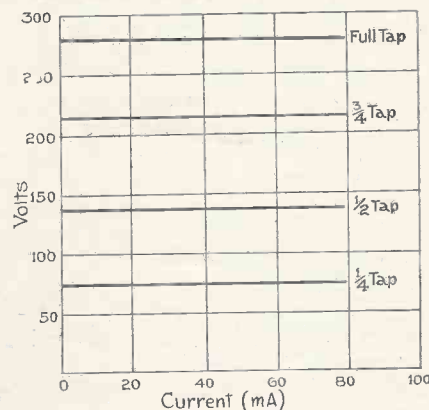

Fig. 3—Typical Stabilovolt characteristics.

trodes, and if we have equally spaced electrodes we get equal voltage tapings all the way up.

The practical form of tube utilises electrodes in the form of cups, which are mounted concentric with one another and all brought out to separate pins on a suitable base. With such a device we find that not only the total voltage but the voltage on the

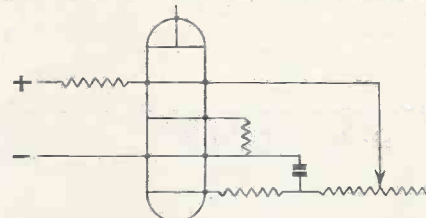

Fig. 5—Time base with constant H.T. control.

various tapings is also constant within the limits just specified irrespective of the current taken either from the whole output or from the tapping points, provided they are within the limits that the tube will stand.

This question of maximum current will be understood by reference to the simple explanation previously given. If there is no load in the external circuit, then all the current will be absorbed by the tube. As we com-

(Continued on page 384.)

BAIRD TELEVISION LTD.

WORLD PIONEERS & MANUFACTURERS OF ALL TYPES OF TELEVISION EQUIPMENT

BAIRD TELEVISION RECEIVERS

The Baird Receiver, Model T.5, is the finest set offered to the public. Although costing only 55 guineas it provides a brilliant black and white picture larger than that obtainable on any make of receiver now marketed. Among the factors contributing to the set's performance, are simple operation, wide angle of vision, high fidelity sound and excellent picture detail.

Free installation and one year's service.

Remember, Baird Receivers mirror the world! So place your order now.

PRICE 55 GNS.

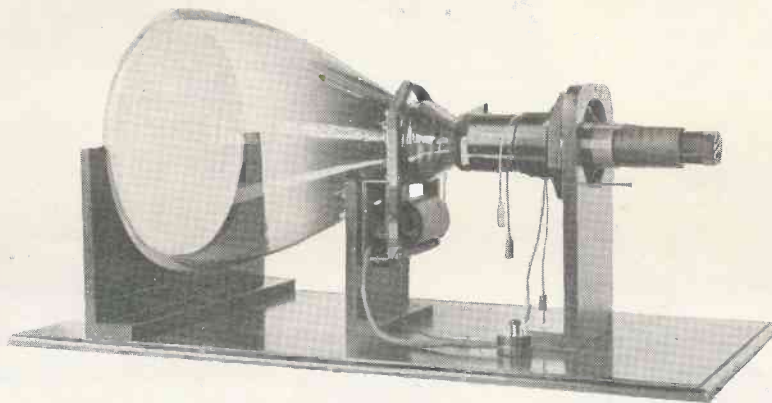

"CATHOVISOR" CATHODE RAY TUBE Type 15 WMI Complete with Electromagnetic Scanning and Focusing Equipment.

BAIRD MULTIPLIER P.E. CELLS

Baird Multiplier Photo Electric Cells are made in two main types. The first has a small cathode of 15 sq. cms. for use with a concentrated light beam, while the second has a large cathode of 250 sq. cms. for diffuse light.

The Baird Multiplier has a chain of electron permeable grid stages and current gain factors of the order of 100,000 can be obtained. Cathode sensitivity is approximately 30 micro-amperes per lumen and the good spectral response enables the cells to be used for infra red detection and infra red signal amplification. Details on application.

BAIRD CATHODE RAY TUBES

TECHNICAL DATA

TYPE 15 WMI.

Heater volts	1.8 volts.
Heater amps	2.4 amps.
Peak to peak volts, between black and highlights	30 volts.
Maximum electromagnetic sensitivity	2 mm/AT.
Modulator/earth capacity	2 μ F (approx.).
Modulation sensitivity (slope)	6 μ A/V.
Anode volts	6,500 volts.
Maximum input power to the screen	3.5 milliwatts/sq.cm.
Maximum anode current for high-lights still in good focus	100 μ A.
Screen colour	Black and white.

GENERAL

The Baird Cathode Ray Tube, type 15 WMI, has a hard glass bulb whose screen diameter is 38 cms., total length 74 cms., and neck diameter of 4.45 cms. Apart from manufacturing processes, stringent tests are made for electrical emission, tube characteristics, filament rating and screen quality, and following normal picture reconstitution under service conditions, the completed cathode ray tube is subjected to a very high external pressure test.

All "Cathovisor" Cathode Ray Tubes are completely electromagnetic in operation, a feature of outstanding advantage. Furthermore, not only is the electrode system extremely simple and robust, but due to the special form of cathode employed, a high intensity cathode ray beam is produced which results in a very brilliant picture.

The ideal tube for really large television pictures—12 in. by 9 in.—without distortion.

LIST PRICE, 15 GNS.

Head Office:

GREENER HOUSE, 66 HAYMARKET,
LONDON, S.W.1.

'Phone: Whitehall 5454

Laboratories:

CRYSTAL PALACE, ANERLEY ROAD,
LONDON, S.E.19.

'Phone: Sydenham 6030

MULLARD
TYPE E46-12
FOR TELEVISION

PRICE

15 GNS



Mullard

CATHODE RAY TUBES

Mullard have held for years a unique position as pioneers in the Radio industry. Mullard Master Valve reputation is upheld in the new field of Television by the Mullard Cathode Ray Tubes. TYPE E46—12 FOR TELEVISION. Double Electrostatic Deflection. Sensitivity 650/v. Maximum Anode Volts 6,000 v. Screen 12", White. PRICE 15 GNS.

● A full list of Mullard Cathode Ray Tubes for Television and other purposes will be supplied upon application and we invite trade enquiries and queries.

Mullard Wireless Service Co., Ltd., Mullard House, 225, Tottenham Court Road, London, W.1

cvs-70

THE FIRST REAL TELEVISION "O.B."

HOW THE CORONATION PROCESSION WAS TELEVISED

ALTHOUGH the televising of the Coronation Procession was not the first actual outside broadcast that has been made, it was the first to employ outside equipment and it differed very materially from the transmissions that have taken place within the precincts of the Alexandra Palace.

It brought into service for the first time the B.B.C.'s new mobile tele-

with this control room. The actual cameras are similar to those in use at Alexandra Palace.

The apparatus in the mobile control room is mounted on racks along the sides of the vehicle leaving clear a centre passageway for the engineers operating the equipment. Two picture-monitors are mounted at one end of the van and while one of these is used to monitor the picture which

small sound control room with all the necessary "faders" and amplifiers to deal with the four microphones which pick up the voice of a commentator and sounds associated with the scene being televised. The sound control room can be linked with Alexandra Palace by ordinary line.

Two Links with A.P.

The conveyance of the picture signals to the Alexandra Palace is possible by two methods. The normal channel is a special television cable having characteristics suitable for the transmission of the very wide band of frequencies which is involved. This cable has been laid by the Post Office from Hyde Park Corner to Broadcasting House and from Broadcasting House to Alexandra Palace, and forms part of a television cable at present being laid in the centre of London passing points of interest from which television broadcasts may be carried out later on.

In addition there is available an alternative channel provided by the second vehicle which contains a complete ultra-short-wave vision transmitter having a power of 1 kW for use with which a small easily erected aerial system has been designed. Picture signals from the mobile control room can be conveyed by means

(Continued at foot of page 339)



The mobile television control room used for televising the Coronation Procession.

vision unit. Owing to technical reasons which limit the length of the cable connecting the television cameras with the control room, previous television outside broadcasts have been confined to the grounds of the London Television Station at Alexandra Palace.

is being transmitted, the other allows the picture incoming from the second camera to be inspected to determine its suitability for transmission.

The vehicle is also equipped as a

The Mobile Unit

The mobile television unit was constructed to enable scenes at a considerable distance from Alexandra Palace to be broadcast. It has been designed and supplied to the order of the B.B.C. by the Marconi-E.M.I. Television Co., Ltd. The unit consists of three vehicles each the size of a large motor coach. The most important of these is a mobile television control room, shown by the photograph on this page, containing all the equipment necessary for the operation of three television cameras. Special multi-core flexible cables, which can be up to 1,000 feet in length, connect the Emitron cameras

Map showing the arrangements made for transmitting the vision signals from Apsley Gate to Broadcasting House and thence to the Alexandra Palace.

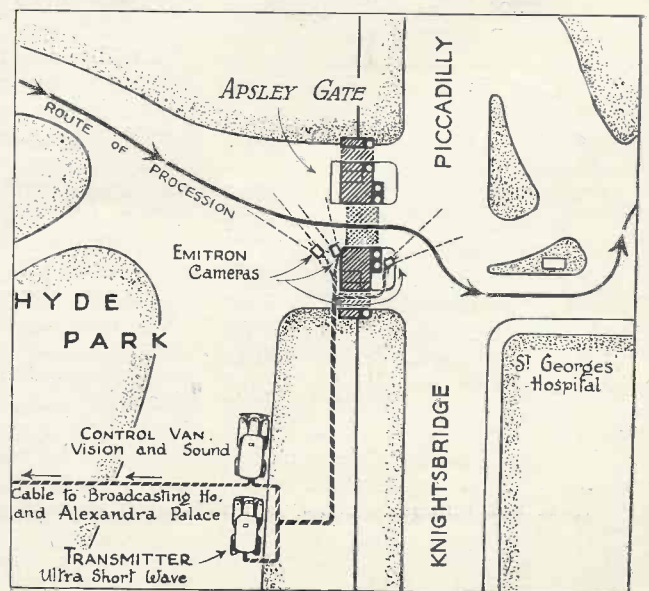



The Science Museum, South Kensington, where the Television Exhibition which is to be opened on the 11th of June will be held.

TELEVISION EXHIBITION AT THE SCIENCE MUSEUM

OPENING JUNE 11TH, 1937

AS has been announced in previous issues of TELEVISION AND SHORT-WAVE WORLD, the first all-Television Exhibition ever to be held in this country is to be opened at the Science Museum, South Kensington, on June 10, by Lord Selsdon, Chairman of the Television Advisory Committee. The Exhibition is being held by the courtesy of Colonel E. E. B. Mackintosh, D.S.O., Director of the Science Museum, and has been organised by Mr. G. R. M. Garratt, M.A., in co-operation with a Committee composed of representatives of the B.B.C. and the leading television manufacturers. The Exhibition will be open to the public on June 11 and will remain open for about three months, so there will be ample opportunity for all readers to visit it.

The Science Museum is open from 10 a.m. to 6 p.m. on Mondays, Tuesdays and Wednesdays; from 10 a.m. to 8 p.m. on Thursday, Fridays and Saturdays and Bank Holidays; and from 2.30 p.m. to 6 p.m. on Sundays. Admission is always free.

Although readers of TELEVISION AND SHORT-WAVE WORLD have followed the technical development of television for a long period, the general public has remained surprisingly ignorant, and it cannot be denied that even to-day, the vast majority of the public have never seen a demonstration. To those entirely unconnected with practical radio, the development of modern television has seemed to have taken place very suddenly. It has made its debut in an advanced state of perfection, unheralded over a period of many years. This apparently sudden develop-

ment of television has caused the wider public to regard it with some degree of hesitation and scepticism and it is with a view to demonstrating that television has now emerged from the experimental stage, to illustrate the general principles which underlie modern technique, and to foster the widest possible appreciation of television as a home entertainment that the forthcoming exhibition has been organised. The exhibition will incorporate a historic section dealing briefly with early proposals for television, and numerous exhibits will describe the developments of the past ten years. There will be a working demonstration of 30-line television using part of the apparatus which was employed by the B.B.C., there will be numerous demonstrations of cathode-ray apparatus and modern receivers will be used for reproducing the B.B.C. programmes.

In addition to the B.B.C. transmissions a local transmitter is being installed in the exhibition which will provide programmes from cinema films at intervals when there is no programme available from Alexandra Palace.

In addition to the cathode-ray receivers, one of which will be provided by each of the manufacturers, there will be demonstrations of large-screen television by Messrs. Scophony, Ltd., and the International Television Corporation, Ltd. It is not yet quite certain, however, that these two latter demonstrations will operate from the Alexandra Palace transmissions.

In connection with the exhibition a handbook has been compiled by Mr. G. R. M. Garratt, assisted by

members of the Executive Committee. The handbook contains a brief account of the early proposals for television, chapters on photo-electricity and light control, the cathode-ray tube and electron cameras. Further chapters describe the lay-out of the television transmitter, television receivers, aerials and feeders, and a general description of the London Television Station at Alexandra Palace. Copies will be on sale at the Science Museum on and after June 10, or may be obtained from any branch of H.M. Stationery Office, or from any bookstall, at the price of sixpence. A review of the handbook will be included in our next issue.

Low-Priced Apparatus for Constructors

To enable experimenters and amateurs to construct high-definition receivers, the Mervyn Sound & Vision Co., Ltd., are making a special offer of kits and units for building first-class high-definition apparatus. The prices of the high-grade components will enable many experimenters who have not yet built a television receiver on account of the cost to do so immediately. As an illustration, a double time-base can be purchased for 65s., while a power unit for this will cost only £6. The 4,000 volt exciter unit with a control panel now costs only £5.

Valves are not included in the kits, and experimenters will find that if one unit at a time is built it will be more convenient to purchase the valves when required. The I.F. transformers used in the vision receiver can now be purchased at 6s. each.

Scannings and Reflections

AN EXTRA TRANSMISSION

A forecast last month, a decision has now been made to inaugurate a daily extra period of transmission lasting approximately an hour every weekday between 12.30 p.m. and 1.30 p.m. The purpose of this is to assist the trade in giving demonstrations at a convenient time of the day, and the B.B.C. emphasises that the transmissions are for this purpose only, and are not intended for the entertainment of home viewers. On this account the transmission will be a repetition daily of a film which has been specially produced by the B.B.C. surveying the activities of television since the service opened, about six months ago. It is perhaps rather unfortunate that it has been found necessary to use a film for these transmissions for, generally speaking, films do not transmit so well as actual studio scenes, though much depends upon the type of film.

REARRANGEMENT AT THE PALACE

Up to the present practically no use has been made of the space rendered available by the removal of the Baird apparatus from the Palace, so in order that certain re-adjustments can be carried out and an overhaul made to the transmitting gear, it has been decided, with the concurrence of the Television Advisory Committee and the approval of the Postmaster-General, that transmissions will be suspended for a period of three weeks commencing on Monday, July 26.

THE SUCCESS OF THE CORONATION TRANSMISSION

Despite the dull weather, viewers are in general accord that the Coronation Procession transmission was a huge success. At a distance of 18 miles from the Alexandra Palace our personal experience, using a G.E.C. receiver, was that it would have been difficult to have had anything better if one excepts a certain amount of dullness due to the bad light; and in any case this was a true portrayal of

conditions as they actually were. The pictures remained perfectly steady for the whole of the period and no adjustment whatever was made to the receiver.

It is interesting to note that the cinema news-reel men operating near the television cameras had to give up owing to lack of light.

CORONATION FACTS

Very full advantage was taken of the Coronation transmission, not only in London, but in places distant approximately seventy miles away. An Ipswich viewer said that both sound and vision were received perfectly, and from Rochester (Kent), also came a report of good reception. A viewer at Fleet (Hants), thirty-seven miles away, also saw the procession perfectly. At the Odeon Cinema, Southgate, a hundred people after seeing the procession on the receiver that has recently been installed there, stood up and cheered wildly.

The General Electric Company, in collaboration with their dealers, organised 200 viewing rooms throughout the reception area, embracing towns as far away as Brighton, a small charge being made in aid of hospitals and other charities. One dealer organised a special demonstration for cripple children unable to attend the L.C.C. parade on the Embankment. Television sets were installed in the open air for the first time, and at the Ranelagh Polo ground, where there was a set in a marquee. It is estimated that approximately 35,000 people witnessed the procession by television.

WHAT THE PRESS SAID

The Daily Telegraph.—The supreme triumph of television to date was marred only by a stroke of ill luck. At the moment televising was about to begin the visibility grew bad.

Such details as the emu's feathers in the Australian's slouch hats, and the plumes in the Guards' bearskins showed plainly on the screen.

Good as the pictures were, sun-

shine would have improved them by 50 per cent.

The Evening Standard.—Nearly 50 miles away every one of us saw more of the procession than we would have done had we been in a 20 guinea seat on the spot.

The Financial Times.—It was the first outdoor event to be televised and was regarded in the nature of an experiment. Despite the adverse weather conditions the amount of detail clearly shown suggested that the future of television is almost unlimited.

THE ABBEY CEREMONY

Most of us have now seen the films taken inside the Abbey and we must congratulate the technicians who made it possible. It is indeed a pity that television was kept outside, but such is the penalty of instantaneous reproduction. Even if there had been a delay of ten seconds we believe the authorities would have allowed it. In the films there was an almost complete absence of "panning" shots, which indicates how the cine cameras were "camouflaged" and therefore completely immobile.

ITALIAN TELEVISION PROGRESS

Safar is the only firm in Italy with a television system of its own. It has obtained the contract for Italy's first television transmitter which is to be erected at Rome, and which is to be ready by February, 1938. It will be a 30 Kw transmitter. The number of lines employed will either be 405 or 441. The station will probably be placed in the grounds of the 1941 Universal Exhibition at Rome.

As in other countries, the great interest of the military authorities in certain applications of television makes it impossible for those concerned to publish all details of their work. It is therefore only possible to briefly outline the principles of the Safar system: It employs the full power of the transmitter for transmitting the synchronising impulses. This will improve reception on the fringe of the service area. (The Safar television receiver employs 15 valves; magnetic deflection is used both for

MORE SCANNINGS

the line and picture frequencies. Ironcore coils are employed for this purpose.

The Castellani "electric eye," the "Telepantoscope," is now being manufactured. The sensitised surface in the tube consists of very thin lines of a secret material treated with caesium and supported by a sheet of mica. In the present model, the picture is scanned by a small mirror-wheel, but it is intended to eliminate this mechanical method very shortly.

SECRETS

When we go to the Palace on various occasions we are very courteously treated, but we have never, nor has anyone else that we have known, seen under the cover of a camera. We must thank Mr. Cock for recently showing us one of these minor mysteries during his recent talk on televising the Coronation.

A NEW CAMERA

It is reported that a new camera is being developed by the Marconi-E.M.I. Co., which will be much more sensitive than the present ones employed. It is expected that with this camera the illumination intensity of the subject being televised need not be so great as at present, and therefore it will facilitate the televising of events where high intensity illumination is not possible. Also by permitting a smaller aperture to be used the depth of focus will be considerably increased and will make operation more simple.

A NEW POST OFFICE REGULATION

In the past, the G.P.O. have issued special licences permitting experimenters to use oscillators for test purposes. It has been decided that the ordinary receiving licence will in future be extended to include the use of modulated oscillators for the transmission of gramophone records, provided it is coupled to a receiver by wire and screened in such a manner as to prevent, as much as possible, radiation from the oscillator.

Providing the oscillator is not allowed to radiate and that the connecting link between oscillator and receiver is efficiently screened, there is no need to obtain a new licence for the oscillator. A special oscillator licence for use under different conditions to that stated above, costs 10s. per year.

THREE FRENCH RADIO EXHIBITIONS

The Spring Exhibition of the S.P.I.R. concludes on May 30. It is being held at the "Neo-Parnasse," 241, Boulevard Raspail, Paris. The Paris Fair Salon has had its finishing date fixed at June 7, while a special pavilion is being provided for radio exhibitors at the forthcoming International Exhibition, which opened on May 24 and is to last for six months.

TELEVISION AT OLYMPIA

The R.M.A. Exhibition to be held this year at Olympia between August 25 and September 4, will have a special radio theatre and section devoted to television demonstrations situated in the National Hall. In the Grand Hall Britain's foremost radio component and receiver manufacturers will have stands, while in the Gallery stands mainly for wholesalers will be allotted.

SOVIET TELEVISION

As an indication of the progress made by British television engineers, Messrs. Scophony, Ltd., are supplying a complete transmitting and receiving equipment to the Soviet Government. This equipment is to be erected in Moscow and includes two types of receiver; one giving a picture 24 ins. by 22 ins. and the other 5 ft. by 4 ft. for public viewing.

The order was placed after a technical delegation were given a demonstration of the definition and brilliancy obtained with this system.

AUSTRALIAN MOBILE TRANSMITTERS

A mobile transmitter housed in a railway carriage is in continuous use in Australia. The call-sign is 3YB and the station is licensed to radiate in any part of the State of Victoria, and automatically becomes the local station of the town visited.

Radio station 3YB has a rated input of 50 watts and works on 1060 kc., but despite its low power it is being picked up over very long distances. The reports received vary according to the location chosen, but several instances have come to light where the programmes have been received at distances greater than 1,000 miles.

BAD SHORT-WAVE CONDITIONS

Users of all-wave receivers should not be discouraged if they fail to receive the usual quota of short-

wave stations at present. During the past few weeks conditions have been so bad that some of our readers have gone to such lengths as sending their receivers back for overhaul. The American Federal Radio Commission declare that these bad conditions, at any rate as far as American stations are concerned, are due to the unusually bad electrical storms prevailing over North America.

Not only on 20 and 10 metres are conditions bad, but even on the amateur wavelengths of 40 and 80 metres. There is no indication when conditions are likely to improve, although it was expected that 1937 would prove to be an exceptional year for long-distance reception. Fortunately, this bad spell does not have any effect on television signals, even at long distances.

SHORT WAVES FROM SWEDEN

Unlike the majority of important European countries, Sweden has not paid any great attention to the beneficial effect of short-wave radio on their Nationals living abroad. For the past year or so Swedish short-wave transmissions have been undertaken by the semi-amateur station, SM5SX, which has been allocated the special frequency of 11,705 kc. The station can also be heard operating on the amateur band on 14,341 kc., and uses an input of 500 watts. Plans are being made to broadcast on 19 and 31 metres with more power and directional aerials, so that Swedish programmes will in the future have world-wide audiences.

A NEW BRITISH RECORD

Despite the fact that conditions have been so extraordinarily bad on the high-frequency bands, a new record has been set up by British amateur Fred Miles, in Kenilworth, under the call-sign G5ML, who is the first British amateur to work Hawaii with phone on 10 metres. Directly the conditions show any signs of improvement there is every possibility that the 10-metre band will again be used for consistent long-distance work in place of the existing congested 20-metre band.

A TELEVISION CENSUS

In order to gain some idea as to the number of people who saw the televised programme of the Coronation Procession, the B.B.C. have under consideration the possibility of a census. If it can be claimed that

AND MORE REFLECTIONS

there is a rapidly increasing interest in television programmes, the B.B.C. feel that they may be able to obtain a portion of the million pounds that is retained by the Exchequer every year from licence fees.

WHAT POWER FOR TELEVISION STATIONS ?

There appears to be some element of doubt as to the number of kilowatts needed to provide a reliable service area from television stations. It is known that 150 kilowatts are essential on long waves, 100 for medium waves, and 40 to 50 on short waves, but no real details are available regarding ultra short-waves.

The peak power applied to the Alexandra Palace station is 17 kilowatts, with a mean power of 10 kilowatts, and although reception is being obtained over a wide area, both the French and American authorities consider 30 kilowatts are necessary, and are building stations to handle this input. As it is output and not input that counts on ultra short-waves it may be that the B.B.C. are obtaining a higher degree of efficiency than their French or American colleagues, in which case 17 kilowatts will probably be sufficient. But it will be interesting to see just what sort of service area is obtained with the new Eiffel (Tower and N.B.C. and Columbia stations.

AMATEURS AND THE ULTRA-SHORT WAVES

It would be interesting to know the reason for the widely differing results obtained by American, Australian and British amateurs on 5 metres. In America the 5-metre band is used more like a telephone service up to 120 miles, while signals are often transmitted from the east to west coasts.

Australian amateurs feel very pleased if they can transmit signals up to 80 or 90 miles, despite the more open country and favourable conditions.

Twenty-five to thirty miles is the average in England on 5 metres, although the record stands at 220 miles with a solitary one-way transmission to America. This lack of success may be due to apathy on the part of British amateurs, for it cannot be due to power restrictions, which are not so important on the ultra-short waves.

TELEVISION INVENTIONS

The report of the Comptroller-General of Patents, which was recently issued, states that in the electrical field, the introduction of commercial television had given rise to the substantial increase over the previous year of 20 per cent. in the number of applications relating to television, and of 25 per cent. in those concerned with short-wave wireless generally.

For the second year in succession there had been a fall in the number of applications for patents concurrently with a rise in the number of complete specifications filed. In other words, the proportion of inventions considered worthy of prosecution to the complete specification stage had been increasing.

TELEVISION BY PART EXCHANGE

The demand for television sets is increasing rapidly, and many dealers in the London area are accepting old

wireless sets in part-exchange for television sets. This fact was revealed by a G.E.C. official. "We as a company do not offer any part-exchange terms," he explained. "That is left to the dealers themselves. Naturally, however, we offer every facility we can to dealers, and where a reasonable request is made we are always willing to arrange a demonstration of television reception in the house of a dealer's prospective customer. Our experience has been that where a demonstration is given, in nine cases out of ten a sale follows.

"A great many dealers are finding it well worth while to offer part-exchange terms, and the G.E.C. is receiving a large number of requests for demonstrations. Listeners whose old wireless set are accepted in part-exchange for television sets need not be without a wireless receiver, as a television set is available which also provides radio reception from practically every station in the world worth listening to."

"THE FIRST REAL TELEVISION 'O.B.' " (Continued from page 335)

of a specially screened cable to this transmitter and after radiation picked up on a small aerial situated on the top of the Alexandra Palace mast immediately above the main vision transmitting aerial. This aerial is connected to an ultra-short wave receiver, the output of which is applied to the main vision transmitter and broadcast in the usual way.

By the use of different wavelengths and special filter circuits, it is possible to avoid interference between the signals being received from the mobile transmitter and those being re-broadcast from the transmitters at Alexandra Palace.

In the case of the Coronation transmission this was a stand-by which it was not necessary to use, but it will be useful on future occasions at points not reached by the special cable.

The mobile control room and transmitter are designed so that they can be operated from electricity supply mains. In situations where suitable mains supply is not available, however, the power for these two units can be supplied by the third vehicle which contains a petrol-engine-driven generator. Special precau-

tions have been taken in the design of this generator-set, both in regulating the speed and governing of the petrol engine, and in the electrical control of the generator, in order that the supply of electricity shall be free from fluctuations which would adversely affect the operation of the television apparatus. Supply mains were available on the occasion of the Coronation transmission and it was therefore unnecessary to use this unit.

Two of the cameras employed were fitted with telephoto lenses to pick out the head of the procession as it came down East Carriage Drive. A third camera was installed on the pavement and provided close-ups of the Royal Coach and other important parts of the procession passing through Apsley Gate.

This first real television outside broadcast was a great success and it was marred only by the weather conditions. Actually the results obtained during the tests were much superior as the light was better. It marked a most important step forward in the progress of television by extending the scope of programmes beyond the confines of the studios and their immediate vicinity at Alexandra Palace.

JUNE, 1937

THE OSRAM SECONDARY-EMISSION PHOTO-CELL

SECONDARY-emission photo-cells have sensitivities comparable with or even greater than the gas-filled type of cell hitherto available and they have none of the disadvantages that are associated with the use of gas magnification. In fact they combine the good points of

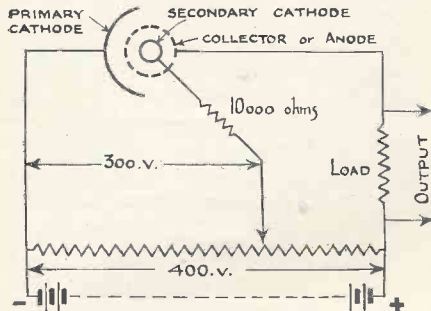

Fig. 1.—Typical circuit for use with secondary-emission photo-cells.

both the vacuum and gas-filled cells with the disadvantages of neither.

In addition to high sensitivity the absence of gas-filling ensures low noise level and a good frequency characteristic to interrupted light. Consequently secondary-emission cells are admirably suited for television transmissions and acoustic reproduction from film as well as for innumerable industrial applications.

The demand for photocells of high sensitivity with stable characteristics has led to the development of the Osram C.W.S.24 secondary-emission type cell.

The appearance and construction of the cell will be clear from the photograph and drawing, Fig. 1. The primary cathode is formed on the silver surface which is deposited on one half of the internal surface of the spherical bulb. The secondary cathode or target is formed on a silver tube which is supported in the middle of the bulb.

The collector or anode is also supported at the centre of the bulb and consists of a molybdenum spiral coaxial with and surrounding the secondary cathode.

Both primary and secondary cathodes are of the caesium on silver oxide type ($\text{Ag}-\text{Cs}_2\text{O}-\text{Cs}$). The collector and secondary cathode are mounted on separate pinches in order to reduce the capacity of the collector to a minimum.

The primary cathode is connected to the grid pin of the valve base, the secondary cathode to the anode pin, and the collector to a screw cap at the top of the bulb.

The glass envelope housing the electrode assembly is evacuated and the primary emission from the cathode impinges on another and secondary cathode which is termed a target from which secondary electrons are ejected by the impacts of the primary electrons. Each primary electron sets free several secondaries so that a magnification of the primary current is secured.

The secondary emission finally reaches a collector which is adjacent

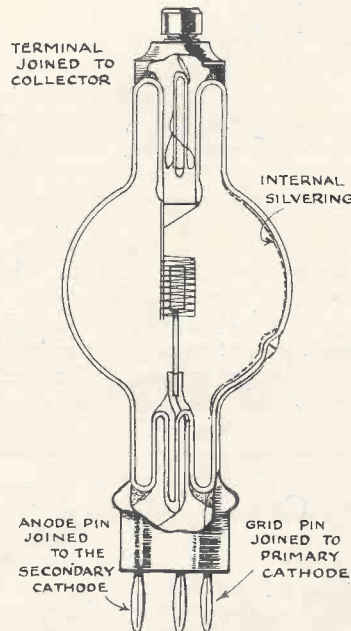
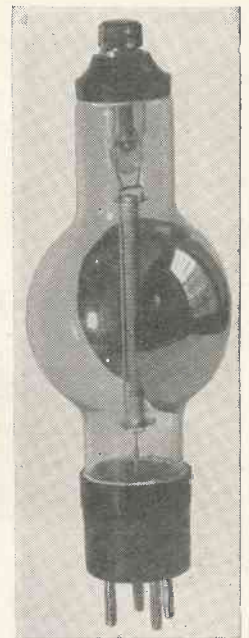

Fig. 2.—Constructional details of the Osram secondary-emission photo-cell type CWS 24.

to the target and which performs the same function as the anode in the ordinary photocell.

The collector is maintained at a positive potential with respect to the primary cathode (see Fig. 2). The secondary cathode or target is also at a positive potential with respect to the primary cathode, but at a negative potential with respect to the collector. It is recommended that the potential difference between the primary and secondary cathode be 75 per cent. of that between primary cathode and collector.

The Osram secondary-emission photo-cell type CWS 24.



The total voltage between primary cathode and collector (anode) may be anything up to 800 volts, but under most conditions a total voltage of 500 will be found to give sufficient output.

A safety resistance of 10,000 ohms is inserted between the source of potential and the secondary cathode. The load resistance, whose value will be determined by the purpose for which the cell is used is connected between the source of potential and the collector.

Primary Emission.—The primary emission of the cell after a preliminary ageing period during which it rises steadily from about $15 \mu\text{a}/\text{lumen}$ is of the order of $40 \mu\text{a}/\text{lumen}$.

Secondary Emission Coefficient.—This factor, defined as the ratio be-

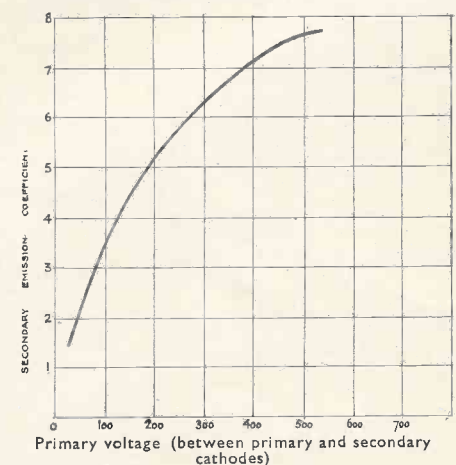

Fig. 3.—Variation of secondary-emission coefficient with primary electron voltage.

A MULTI-C.R. TUBE SCREEN FOR LARGE PICTURES

By Morton Barr

Details of an ingenious scheme employing a light amplifier.

MANY people hold the view that the future of television lies as much in the cinema theatre as in the home. Whether this is so or not, there is little doubt that the time will come when "pictures by television will form part of the daily bill of fare at the cinema. The difficulty is, of course, to produce pictures of sufficient size to cover the ordinary cinema screen, with sufficient detail and brilliance.

The use of cathode-ray systems seems, at first sight, to be barred by the fact that the size of the picture

An early attempt to produce a large-scale picture involved the use of a special "mosaic" viewing-screen built up of a large number of small lamps, each of which represented a single picture element. Each of the lamps was wired up to a corresponding P.E. cell forming part of a similar "mosaic" surface which was

least a light of equal intensity spread over a larger surface. In either case the result will be a larger image, having at least the same brilliance and definition as the original.

As shown in Fig. 1, the incoming picture signals are handled, in the first place, by a cathode-ray receiver C of standard size and make. The picture thrown on the fluorescent screen of the tube is next focused on to screen S built up of small photo-electric cells, each of which corresponds to a single picture element of the original.

This forms the light-relay, which is linked up, in a manner to be explained, to the final or full-sized viewing screen marked V. Here each picture-point is represented by a single source of light, which for the moment we may call a lamp.

Each part of the picture, as it first appears on the fluorescent screen of the cathode-ray tube, is projected by a lens L on to the bank of photo-electric cells, where it creates a current corresponding to a particular light or shade value. The resulting currents are passed on to the corresponding group of "lamps" comprising the larger viewing screen V, where they reproduce the same light effects, on a larger scale, as indicated by the diamond-shaped areas marked A, B, and C.

The real merit of the arrangement lies in the neat way in which the two

Fig. 1. The first screen consists of a number of photo-electric cells, the current from which actuates a bank of simple cathode-ray tubes comprising the second and larger screen.

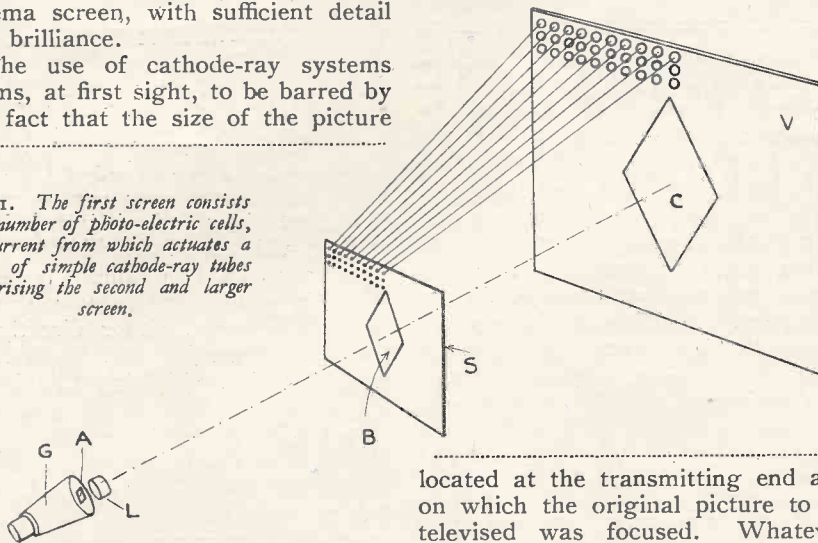

is necessarily limited by the size of the glass bulb, and that it is not possible to construct a tube of the dimensions required.

One possible solution of the problem is to receive the picture, in the first place, on a cathode-ray tube of normal size, but instead of viewing it direct, the picture produced on the fluorescent screen is recorded on a cinema film, which is immediately developed and fixed. The film is then passed through a standard type of optical projector, which magnifies it in the ordinary way up to screen size.

This scheme, which is, of course, an adaptation of the well-known "intermediate film" system as used for transmission, is limited by the fact that the received fluorescent image is of poor light intensity and therefore is not well suited to make a clear-cut record on a photographic film. This naturally affects the detail and brilliance of the magnified image, when projected from the film on to a full-sized cinema screen.

located at the transmitting end and on which the original picture to be televised was focused. Whatever variations of light and shade occur on the photo-electric surface were then automatically reproduced on the screen of lamps. (The idea, though elementary in principle, is almost impossible to carry out in practice on account of the complexity and cost of the apparatus required.)

Quite recently the idea of using a large number of small lamps to form a viewing screen has again been put forward, this time in combination with a cathode-ray receiver. As already mentioned, the disadvantage of the cathode-ray tube, when it comes to producing large-scale pictures, lies in the fact that the fluorescent screen gives off too little light to allow of direct magnification by lenses.

This difficulty can, however, be overcome by introducing a suitable form of "light amplifier" between the fluorescent screen and the final viewing screen. For instance, if the fluorescent light is allowed to act on a photo-electric cell, the latter will generate a current which can be used to produce a stronger light—or at

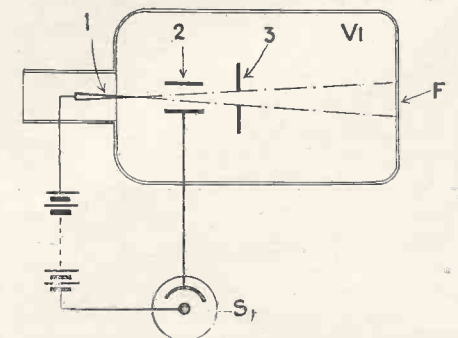

Fig. 2. Diagram showing how the elements of the two screens are linked together.

screens S and V are linked together. This is illustrated in Fig. 2, where the photo-electric cell marked S1 represents one of the bank of cells mounted on the screen S, whilst the

tube marked V₁ is one of the "sources of light" which go to form the viewing screen V.

Actually the tube V₁ is a small cathode-ray tube of very simple design. It contains only a cathode 1, a control grid 2, and an anode 3, the latter having a central aperture through which the electron stream passes, without deflection and at uniform strength, on to a fluorescent screen F. It must be borne in mind that each of the cells on the screen S, and each of the lamps (cathode-ray tubes) on the screen V, corresponds to a single picture element, so that each handles only a single spot of light. Although this spot will vary in intensity from time to time, as the

televised picture changes or "moves," there is no necessity for any scanning operation to be performed.

As the light falling on the P.E. cell S₁ changes, the potential on the control grid 2 is varied to regulate the intensity of the stream falling on the fluorescent screen F, and therefore the intensity of the light produced by the CR tube V₁. Since the screen F is uniformly illuminated it acts in exactly the same way as a lamp (or a point source of light) on the viewing screen V. In this way every change that occurs on the screen of the original cathode-ray receiver C, shown in Fig. 1, is repeated on the large-scale viewing screen V.

inside of the sphere and how the unit, the lumen, is derived. The area of the sphere is $4 = 12.57$ square feet. If we take one square foot of the interior, a difficult quantity to measure, although simple for our purpose, we can say that the illumination falling upon an area of one square foot in the sphere is one lumen. Similarly, the quantity of illumination which can be obtained from a uniform light source of one candle is 12.57 lumens.

It may be well to emphasise the importance of candle-power and its relation to luminous flux. The total flux

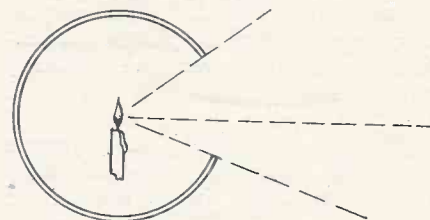

Fig. 2. Diagram explaining the lumen.

THE MEASUREMENT OF LIGHT INTENSITY

THERE are four fundamental concepts associated with light; the luminous flux, luminous intensity, illumination, and brightness. Luminous intensity is sometimes termed candle-power.

Luminous flux may be stated as the rate of flow of radiant energy evaluated with reference to visual sensation.

Luminous intensity, or candle-power, is the term used to indicate the solid angular density of the flux in a given direction. Let us assume, for instance, that we have a light source S, of one candle (Fig. 1) situated at a distance of one foot from a sheet of paper P. The intensity of light would be one foot-candle. If the strength of the light rays were the same in all directions the intensity of light at any point round the candle, at a distance of one foot, would be one foot-candle. If we were to enclose the light source in a sphere, with a portion of the wall cut away as illustrated in Fig. 2, providing that the reflection factor of the interior of the sphere is zero the intensity of light at one foot distant would still be one foot-candle. This brings us to the term lumen, which is the unit of luminous flux and is equal to the flux emitted in a unit solid angle whose average candle-power throughout the unit solid angle is one candle.

Referring again to Fig. 1, the intensity of illumination falling upon the sheet P is not even. The reason

is that the distances from the light source to the sheet are different. Let us assume that the sheet is one foot square, that it is perfectly vertical, and that, from an alignment point of view, the candle is situated in a horizontal plane with the centre

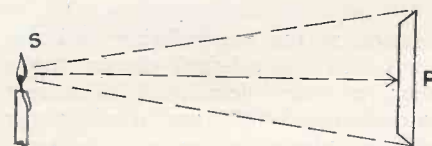

Fig. 1. Diagram showing how luminous intensity is determined.

of P. (The centre of P would be the nearest point to the light source. The corners of P would be the farthest away.)

It can be seen how difficult it would be to measure the quantity of illumination of a light source by any means in which angles or sides were involved. Since, however, the intensity of illumination from a light source must be readily calculated, it may be said that the method adopted is to imagine a light source in the centre of a sphere which has a diameter of two feet. The distance from the source to any point of the sphere is one foot, and, assuming an even distribution of light from the source, the intensity of illumination at any point on the inside of the sphere will be the same.

We now have to consider the

in lumens of a standard lamp (a lamp against which the intensities of other light sources are measured) is determined by obtaining the mean spherical candle-power, either directly or through measuring the mean horizontal, and multiplying this by 4. Candle-power, then, is always associated with a source, whether self-luminous or otherwise, and gives information regarding the luminous flux at its origin.

The Eddystone Dual-speed Tuning Dial

In the advertisement that appeared on page 315 of our May issue a printer's error unfortunately left out the most important piece of information regarding the type 1070 dual speed full vision Eddystone tuning dial. This dial is priced at 8s. 9d. and is suitable for mounting either on a panel or base-board. It is noiseless in operation even on the highest frequencies, while the tuning scale is divided into 100 graduations. In keeping with modern practice, the dial readings increase as the frequency increases. Full information regarding this dial can be obtained from the manufacturers, Stratton and Co., Ltd., Eddystone Works, Birmingham.

A correspondent is desirous of obtaining the November, 1933; January, March and April, 1934, and March and October, 1935, issues of "Television." If any reader can oblige we shall be glad to receive notification and the price required.

RECENT TELEVISION DEVELOPMENTS

A RECORD OF PATENTS AND PROGRESS *Specially Compiled for this Journal*

Patentees:—Radio Akt. D. S. Loewe :: G. W. Walton :: C. Lorenz Akt. :: V. A. Jones and Baird Television Ltd. :: The General Electric Co., Ltd., and L. C. Jesty :: L. R. Merdler and Baird Television, Ltd.

Synchronising Signals (Patent No. 460,709.)

PICTURE signals and synchronising impulses are both produced by a scanning disc which is provided with only one row of scanning holes—without the usual synchronising slot—and operates with only one photo-electric cell. This result is secured by illuminating the picture to be scanned by an additional source of constant light. The area of the doubly-lit surface is made smaller than the spacing of the scanning apertures, so that a photo-electric cell placed behind the disc records a complete disappearance of the lighting during a certain fraction of the total line period.

(The intensity of the extra illumination is such that the current in the transmitting aerial falls to zero during these periods, thereby producing the synchronising impulses.—Radio Akt. D. S. Loewe.

Television Systems (Patent No. 460,721.)

In addition to transmitting the ordinary contrasts of light and shade that go to form details of a televised picture, it is desirable to be able to transmit the changes that occur from time to time in the average or "back-

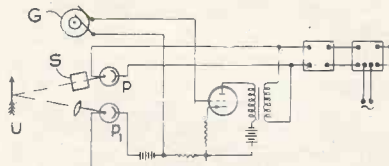

Method of transmitting average values of light and shade. Patent No. 460,721.

ground" brightness of the picture as a whole. Since such changes occur comparatively slowly, they produce currents which are too low in frequency to be handled by ordinary valve amplifiers, and their effect is accordingly lost in the received picture.

The figure shows how the difficulty

can be overcome. The photo-electric cell P is fed with picture detail signals from the object O through a scanning device S in the ordinary way. A second photo-electric cell P_r receives light direct from the object, so that it is affected by slow changes of illumination. The output from this cell is fed to a valve V, together with current from an A.C. generator G, and the two are modulated together. The result is a current which can be handled by subsequent amplifiers and used to control the background brilliance of the received picture. (The frequency of the current supplied by the generator G is a multiple and a half of the frame frequency so that it does not affect the viewing screen.—G. W. Walton.

Keystone Effect

(Patent No. 461,105.)

In a cathode-ray tube of the Iconoscope type, the photo-sensitive screen must be set at an angle to the main axis of the tube, in order to allow the picture to be focused on to it. This means that the electron beam used for scanning sweeps over the picture at an angle, instead of being always at right-angles to the surface of the screen.

In order to prevent this from producing a "keystone-shaped" picture, an extra correcting voltage is added to that normally used for the line scanning, thus producing a frame which is strictly rectilinear. In addition, means are provided for changing the focus of the beam as it moves up and down the picture, so as to produce a clear-cut spot both at the end nearest the cathode, and at the end furthest away from it.—C. Lorenz Akt.

Electron Cameras

(Patent No. 461,197.)

The picture to be transmitted is focused upon a photo-electric cathode C, and the resulting stream of electrons from the cathode is swept over a "line" anode A by the deflecting field from an external winding W.

The anode A consists of an array of separated conducting elements, which, in combination with a common earthed plate P, form a series of small condensers.

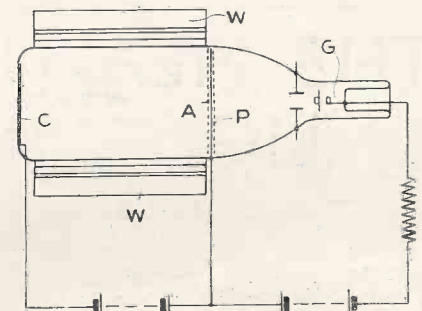

Electron camera. Patent No. 461,197.

The charges set up across the condensers form an "electric image" of the picture, and this is scanned or discharged by the electron stream from the gun G of the tube. The anode A consists of a strip of insulating material coated with metal which is graved or ruled with a series of lines so as to divide the metal into a large number of isolated elements.—V. A. Jones and Baird Television, Ltd.

Mosaic-cell Electrodes

(Patent No. 461,312.)

A mosaic-cell electrode for a cathode-ray tube consists of a very large number of globules of photo-sensitive material. Each globule acts as a minute photo-electric cell, which creates an electric charge corresponding to the light-and-shade value of the particular part of the picture projected on to it. In this way an "electric image" of the complete picture is built up, and is subsequently scanned by an electron beam for transmission.

The mosaic is formed by first coating a sheet M of mica with a thin film T of metal, as shown in Fig. 1. The metal is then separated into isolated strips S, Fig. 1a, by ruling a number of parallel lines L. Each

cell therefore is insulated from its neighbour. Finally a number of strips are assembled to form the completed electrode, as shown in part in Fig. 1b. The figures are drawn on a

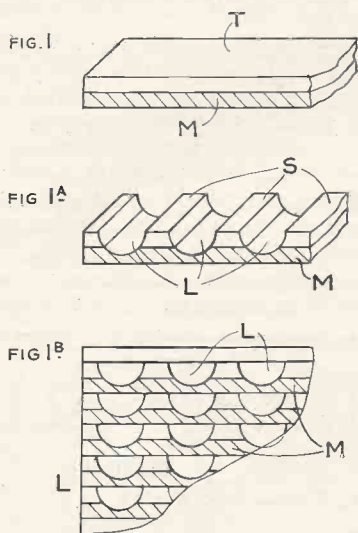

Construction of mosaic-cell electrodes. Patent No. 461,312.

greatly enlarged scale.—V. A. Jones and Baird Television, Ltd.

A Safety Device for C.R. Tubes
(Patent No. 461,374.)

Owing to the size of the glass bulb, and the high degree of the internal vacuum, it sometimes happens that the walls of a cathode-ray tube will collapse. Usually the fragments of glass are driven inwards by the external pressure of the air, so that there is little risk of injury or damage. But since some of the internal electrodes may be biased to several thousands of volts, it is necessary to

provide against any danger from this source.

Accordingly the high-tension circuits include a make-and-break switch which is kept in the "make" position by the pressure of the glass wall of the bulb. If the latter is fractured the switch promptly "opens," and the voltage supply is automatically cut off.—*The General Electric Co., Ltd.*, and *L. C. Jesty*.

Sound and Vision Receivers

(Patent No. 461,983.)

In a superhet receiver for combined sound and pictures, employing a local-oscillator circuit of the Colpitts type, there is some difficulty in ganging the circuits to a single tuning-control. According to the invention a pre-set condenser is connected between "earth" and one end of the tuning inductance. This provides the necessary back-coupling and at the same time permits the tuning-range of the oscillator to be varied. Another pre-set condenser is connected across the tuning inductance and is used as a "trimmer" to bring the circuits into alignment.—*L. R. Merdler* and *Baird Television, Ltd.*

Summary of other Television Patents

(Patent No. 460,675.)

Combined sound and picture receiver in which an A.V.C. bias is applied to the grid of a valve in the sound channel as well as to a valve in the picture-signal channel.—*The General Electric Co., Ltd.*, and *D. C. Espley*.

(Patent No. 460,741.)

System of scanning designed to

give high-definition pictures whilst using only a narrow frequency band.—*E. Michaelis*.

(Patent No. 461,105.)

Cathode-ray television "camera" with a photo-electric screen inclined to the main axis of the tube.—*C. Lorenz Akt.*

(Patent No. 461,128.)

Scanning system employing a single mirror which is vibrated simultaneously in two directions.—*W. H. Priess*.

(Patent No. 461,177.)

Method of preventing fog-formation on the picture due to the amplifiers used at the transmitting end.—*Radio-Akt D. S. Loewe*.

(Patent No. 461,434.)

Photo-electric cell utilising an electrode coated with a fluorescent material.—*D. M. Johnstone* and *Baird Television, Ltd.*

(Patent No. 461,629.)

Method of increasing the effective modulation sensitivity of a cathode-ray tube.—*A. C. Cossor, Ltd.*, and *W. H. Stevens*.

(Patent No. 461,646.)

Improving the sensitivity of cathode-ray television transmitters of the Iconoscope type.—*Marconi's Wireless Telegraph Co., Ltd.*

(Patent No. 461,907.)

Provision of guard plates to prevent "trapezium" distortion in a cathode-ray tube.—*Marconi's Wireless Telegraph Co., Ltd.*, and *A. J. Young*.

(Patent No. 461,999.)

"Smoothing" arrangement for the high-tension supply to a cathode-ray tube.—*C. Szegho, W. P. Anderson* and *Baird Television, Ltd.*

New Stentorian Loudspeakers

Messrs. The Whiteley Electrical Radio Co., Ltd., manufacturers of Stentorian loudspeakers, have made available a new range of instruments without their now famous tapped matching transformer. These loudspeakers are for use with receivers that need an extension loudspeaker having a resistance of 2 ohms.

Owing to the demand for this type of speaker where the special matching transformer is an unnecessary expense, this new range of eight speakers will fulfil an undoubted want. Prices and types have been fixed as follows:—

Standard Cabinet Speaker.	Equivalent Cabinet Speaker without Transformer.
37 SC ... 63/-	37 SX ... 52/6d.

37 JC ... 49/6d.	37 JX ... 42/-
37 CC ... 39/6d.	37 CX ... 35/-
37 BC ... 29/6d.	37 BX ... 24/6d.

The first three are suitable for use with the "Long Arm" remote control, and have the necessary volume control and push button incorporated.

A Low-resistance Filament Choke

An interesting type of smoothing choke has been introduced by A. F. Bulgin & Co., Ltd., of Abbey Road, Barking, Essex. This choke, type LF47S, is for use in circuits with condensers to form a noise suppressing unit. It is also very suitable in L.T. smoothing circuits.

It has an inductance of approximately .25 H with a load of .75 amperes, and has a D.C. resistance of between 6 and 6.25 ohms. The choke is assembled in

the new skeletonised form and is fitted with rubber-covered leads. Price has been fixed at 10s. 6d., which is subject to the percentage increase previously announced.

Octal Valve Holders

Two new octal valve holders are now available from Messrs. Eves Radio, of Old Mill Street, Wolverhampton. The first model has a low loss ceramic body with a metal mounting ring held in position by a spring washer. The holder can be riveted directly to the chassis or mounted above as required.

The second type is similar in principle but has a moulded body, but in both types the contacts are arranged automatically to form soldering lugs. In addition each lug is numbered to assist constructors when wiring the receiver.

TELEVISION IMAGES—

AN ANALYSIS OF THEIR ESSENTIAL QUALITIES

A Paper read by L. C. Jesty, B.Sc., A.M.I.E.E. and G. Winch, A.M.I.E.E. (Mem.) of the Research Laboratory of the G.E.C. at a meeting of The Illuminating Engineering Society.

THE authors of this paper gave a comprehensive survey of picture composition from the photographic and cinematographic points of view and then went on to deal with the practical limitations to the realisation of the ideal picture imposed by the characteristics of television systems. Unfortunately it has been found impossible to give an abstract of this paper with any degree of completeness owing to the inter-relation between the first part dealing with photography and cinematography and the second portion having particular reference to television images. It would be quite impossible to do justice to the authors' work without giving the paper in full. It will, however, be published in the Transactions of The Illuminating Engineering Society.

The authors defined the quality of a picture as being controlled by its contrast, brightness, definition, size, presentation, and tint. In the case of a moving picture, there is also flicker and allied effects. Of these definition is undoubtedly the controlling factor in television reproduction. Even when a basis of transmission is established (number of lines), the best use that can be made of the theoretical definition available is open to a number of practical and commercial solutions.

Dealing with television receivers, the authors said: Two controls are normally available to the user of a television receiver, for the control of the tone values of the picture. One of these governs the amplitude of the modulating signal applied to the cathode-ray tube or its alternative. It corresponds to the "volume" control of a radio receiver. The other control is for adjusting the steady potential of the modulating electrode, so that the signal from the receiver modulates it over the correct range.

The effect of the signal control of the receiver is to reduce the overall brightness of the received picture or pattern, without altering the gamma, and therefore the tone ratios. The effect of the bias adjustment is to alter the level of the tones in the pic-

ture, keeping their brightness differences practically constant. Adjustment of this control is comparatively critical, as will be seen, for misadjustment produces loss of detail in the blacks.

The authors remarked that in no system of picture reproduction hitherto available has it been possible to control the picture characteristics and observe the effect immediately. In this connection television is so far unique, and it is to be hoped that much will be learnt from it, to the advancement of picture reproduction generally.

Picture Brightness

The actual value of the brightness of the television picture is very important, in view of the particular conditions under which it has normally to be viewed. In order that adequate tone range shall be maintained in the received picture, a very important factor must be considered, namely, the brightness of the deepest black in the picture. Here, at first sight, television seems to offer an advantage over other picture reproducing systems, as the scanning spot can be completely blacked out by suitable adjustment of the receiver controls. Hence true black and infinite range should be obtainable. Unfortunately, this condition could only be realisable in practice, provided four conditions were perfectly attainable. These are:—

1. The black level at the receiver and transmitter must be correctly adjusted initially.

2. The black level of the signal must be absolutely maintained throughout the whole system for the duration of the transmission. Slow variations could, of course, be compensated for manually, but rapid variations, or local inequalities over the screen, cannot be so treated.

3. Light must not be reflected from the bright portions of the picture, back on to the black parts. Normally this can occur with any projected picture, by light from the picture being reflected back from the

walls of the room. In the particular case of the cathode-ray tube, as used for television reception, internal reflections can occur inside the bulb, and special precautions in the nature of non-reflecting coatings on the bulb, have to be used to reduce this to negligible proportions.

4. There must be no other source of light present, which can illuminate the screen.

Of the above items, 2 and 4 are undoubtedly the limiting factors at the moment, with 4 probably the most serious, particularly with the advent of summer "viewing."

With regard to 2, the chief trouble with the present transmissions, if a criticism may be offered, seems to be an apparent unevenness of illumination of the subject at the transmitter. It is believed that this is due to some non-uniformity of the photo-cell mosaic of the transmitting tube, and is more particularly noticeable on the film transmissions, where rapid changes of scene occur. This effect has not been noticed to the same extent on mechanical scanners, where the light source and photo-cell are the same for each picture point.

With regard to 4, television presents a special problem, as, in general, the picture has to be viewed under conditions of quite high general illumination, including daylight. Shielding the screen, for example, with a viewing tunnel will assist matters, but, unfortunately, such devices, if at all efficient, narrow the angle of viewing considerably, and should be considered with caution. Other devices have been proposed, and the use of fluorescent materials of low reflection factor will also assist.

Definition and Size

The definition of a television picture is so intimately linked with all the other characteristics, that it probably controls the final picture quality almost entirely.

It is the number of elements, or lines, into which the picture is divided, which controls the maximum

definition obtainable in the final picture. Defects or deficiencies in the whole transmitter receiver chain, can materially reduce the definition below this maximum figure.

(The shape of the ideal scanning spot for use in both transmitter and receiver, would be a line, or at most a very narrow rectangle, whose height is equal to the line width, and breadth the minimum possible. Owing to the practical difficulties of obtaining other than symmetrical scanning spots (round, square, etc.), and also of increasing the brightness sufficiently, some loss of definition due to this aperture distortion has had to be incurred.

The exact significance of differences in definition has been the subject of much discussion. The limit of acuity of vision has been investigated for television line systems, and values between 0.5 and 1.5 minutes of arc have been obtained under various conditions, with a tolerable maximum value of about 2 minutes. A picture of limited definition has a correct viewing distance, dependent on this angle. If this correct dis-

tance is exceeded, then the eye of the observer is not capable of resolving all the detail in the picture, which is wasteful, and if the distance is reduced below the critical value, then lack of detail becomes apparent.

In order to make the maximum use of the definition available with a given number of lines, an exact knowledge of the dimensions, and light distribution, of the scanning spot at the transmitter and receiver must be obtained. For example, to a first approximation the light flux in the scanning spot is proportional to the square of its diameter.

This fact is of fundamental importance in television and has proved one of the most serious limitations from the commencement of the art. Thus, doubling the number of lines in a picture will halve the spot diameter, and reduce the light available at the transmitter and the brightness of the received picture, to one-quarter of its previous value.

With the present B.B.C. transmissions the brightness of the spot has to be some 200,000 times the required picture brightness. This diffi-

culty has now been overcome at the transmitter by the development of photo-electronic devices, such as the Iconoscope, the Emitron, and the electron multiplier; and in the receiver by the large screen, high-vacuum, cathode-ray tube.

Realising, therefore, that the effect of a television picture is produced both by high brightness, to give good contrast, and also by obtaining the maximum definition, the importance of knowing the exact brightness distribution of the spot becomes apparent.

The advantages of large pictures for the home would seem to be negatived somewhat, due to the considerable viewing distance necessary. As and when definition is increased, then advantage can be taken of this to produce larger pictures. Larger pictures will also require greater light output from the receiver in order to maintain brightness. The chief objection to the present size seems to be related to the comparative comfort with which a home cinema picture can be viewed by half a dozen people, but the real difference here is in the relative definition.

TELEVISION'S GUARANTEED CATHODE-RAY RECEIVER

OUR Guaranteed Receiver, which was described in the October, November and December, 1936, issues, and which has proved so successful and capable of providing steady, clear pictures considerably beyond the service area, has undergone certain modifications since the original design.

When the B.B.C. decided to utilise the single E.M.I. system of transmission, we considered that this was a convenient time to consider the possibility of reducing the price of the receiver without affecting the results in any way.

Considerable simplifications have been made to the time base, which has also resulted in a reduction in cost. In fact, this latter point now applies to each section of the complete receiver. By eliminating components and reducing the overall size of units, and making other modifications, the total cost of our Guaranteed Television Receiver is now very much lower.

As the design is so fool-proof and is backed by our guarantee, constructors now have a real reason for building their own television receiver.

From time to time modifications

have been introduced which are the results of our continual research on the original circuit. It must, however, be remembered that the circuit as first published gives excellent results, so that the receiver as originally built need not necessarily be altered. However, new constructors should take advantage of our latest ideas.

One of the big advantages of home construction is that the receiver can be kept up-to-date, which is a decided help in a rapidly changing industry such as television. Designs are continually being altered to incorporate new schemes which are only open to constructors.

We therefore advise our readers to construct this television receiver, not only because it gives really excellent results, but that improvements can be added after they have been found worth while in our laboratory.

It is now possible for readers to see the television pictures with a receiver that costs little more than the average all-wave radiogramophone. A television receiver is not difficult to build, even though the theoretical circuit shown opposite may give this impression at first glance.

The Units

Several units go to make up a television receiver and these can all be made separately and linked together after each unit has passed its individual tests. Constructors who feel that it is beyond their capabilities to build a television receiver should consider the difficulties from another aspect. Rather than gain the idea that a three-valve sound receiver is to be built and an 8-valve vision receiver, both of which embody fundamental radio principles. The power packs are very simple, even though they give high voltages, while the details given to constructors on how to build the time base were so complete that we do not consider any of our readers should have any difficulties.

The range of the signals from Alexandra Palace appear to be at least two or three times the original stipulated service area, so that those readers who may have the idea that they were too far from the station to enjoy television pictures should make further investigations or write to us for advice as to the possibilities of good reception. Remember that there is a guarantee with this receiver that you obtain excellent pictures providing it is built to specification. This guarantee is unique and should remove any element of doubt that constructors may have difficulty in building up the units with success.

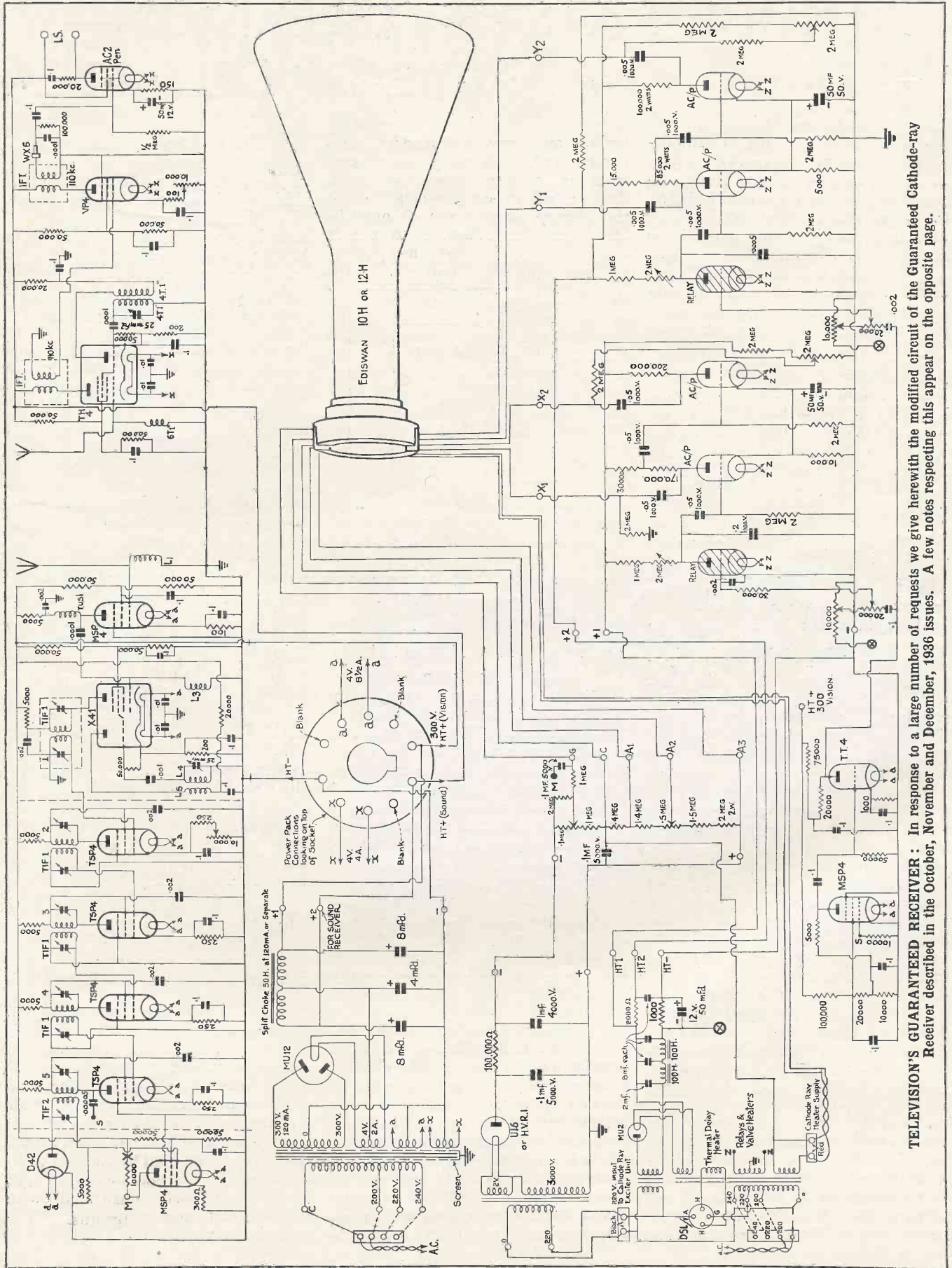

TELEVISION'S GUARANTEED RECEIVER: In response to a large number of requests we give herewith the modified circuit of the Guaranteed Cathode-ray Receiver described in the October, November and December, 1936 issues. A few notes respecting this appear on the opposite page.

CATHODE RAYS FOR TELEVISION— A 30-YEAR OLD IDEA

ALTHOUGH the use of cathode-rays for television is generally regarded as a very recent development, actually the idea is nearly thirty years old, though obviously at that time the carrying out of the scheme was impracticable. It was in June, 1908, that Mr. A. A. Campbell Swinton first suggested the employment of cathode-rays for scanning an image. Nearly a year later the Russian scientist, Professor Boris Rosing, put forward a somewhat similar scheme.

Campbell Swinton's original plan was made public in his address to the Rontgen Society in 1911, and he stressed the point that it was a suggestion only and not a practicable working scheme: That it contained the germ of modern development will be clear from the accompanying diagram and explanation.

The tubes it was proposed to use were the cold-cathode type, and deflection of the cathode stream was to be brought about by applying the varying fields of two electro-magnets placed at right angles to one another and energised by two alternating currents of widely different frequencies, say, 1,000 and 10 complete alternations per second. Some 100,000 volts, it was stated, must be applied for successful operation in securing a sharp point on the screen. D, D₁, and E, E₁, are electro-magnets which cause the vertical and horizontal movements of the beam, D and D₁ being fed from the same alternator, while E and E₁ are similarly fed from the same alternator G.

An interesting point is the small metallic screen J. This is "gas-

tight," and formed of a large number of very small metal cubes, each carefully insulated from the others. These cubes, it was suggested, would be of some metal such as rubidium

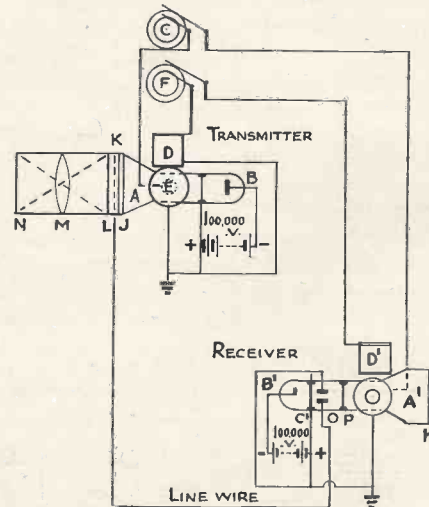

Campbell Swinton's suggested scheme for cathode-ray television.

(which is strongly active photo-electrically), so that they will readily release electrons when light is caused to fall upon them. On the other side of the screen is a chamber K containing a gas or vapour, such as sodium vapour, which is for the purpose of assisting conduction of the electrons across the space to the metallic gauze screen L, more readily in the case of light patches of the screen J than in the case of dark patches.

It was suggested that the apparatus would function in the following way.

A uniformly steady beam of cathode-rays is caused to scan one side of the screen J, while on the other side there is an image of the object, N, which it is desired to transmit. This image is projected by the lens M through the gauze screen L on to one side of the screen J.

As the cathode-rays scan the surface of J, they will impart a negative charge to each little cell in turn. In the case of those cells brightly lighted on the reverse side, the charge will pass away through (and be assisted by) the ionised gas in the chamber K, until it reaches the screen L. In the case of dark patches no further conduction will take place.

The Receiver

The proposed method of controlling the cathode beam at the receiving end as it passes through the metallic plate O is as follows. Just beyond this plate, and nearer the viewing end of the tube, a diaphragm P is fitted, so arranged that it will normally succeed in cutting off rays emitted from B₁, and so prevent them reaching the screen H unless they are slightly repelled from the plate O. The image signal coming through at any instant, in charging the plate O, allows the cathode beam to strike the screen H and momentarily produce a bright spot.

In the light of modern knowledge it will be appreciated that the scheme could never have worked in the form suggested and so far as is known no attempt was made to build apparatus to put the idea into practice.

Book Review

Electronic Television, by George H. Eckhardt (The Goodheart-Willcox Company, Inc., 2009 Michigan Avenue, Chicago).

This book is unique by reason of the fact that it deals with the subject of its title without any reference whatever to mechanical scanning; as its title implies it is devoted entirely to electronic methods. The book is

based upon the work undertaken in the laboratories of Farnsworth Television Inc. and R.C.A., and in its preparation the author has had the assistance of research workers of these two concerns. The book is divided into three parts. The contents of the first include a description of the Farnsworth system; secondary electron multiplication; the Farnsworth camera; the R.C.A. system, including transmission. Part II deals with electronic reception with des-

criptions of both the Farnsworth and R.C.A. systems. Part III is devoted to electron multiplication, electron microscopes, etc.

The book is a popular exposition of electronic television and the author has succeeded in making the general principles so clear that they will easily be understood by the non-technical reader. It contains 160 pages and is profusely illustrated with photographs and diagrams. The price is \$2.50.

STUDIO & SCREEN

A MONTHLY CAUSERIE on Television Personalities and Topics

by **K. P. HUNT**
Editor of "Radio Pictorial"

IT is known that about 3,000 television sets are in service, and it can safely be assumed that every one of these sets was in use on the occasion of the momentous Coronation broadcast.

This intensive use of all the available instruments is exemplified, for instance, in the demonstrations that were given by the G.P.O. in the Memorial Hall, St. Martin's le Grand. Six receivers were working and the Coronation was seen by as many as 500 people, mostly distinguished visitors, Post Office officials and their wives and friends, all of whom saw this great historic event in comfort.

No single broadcast since the beginning of the service in this country has done so much to publicise the B.B.C.'s work in television or generally to acquaint people with the wonderful strides that have been made, and to arouse in them a desire to possess a television set of their own.

The broadcast itself went off perfectly. The position of the cameras gave an even better view than was expected, and Mr. Gerald Cock, the B.B.C.'s popular television chief, said that if only it had been possible to use the telephoto lenses as was planned, he would have put out a picture which would have surprised many people even at Alexandra Palace. Unfortunately, the poor visibility on Coronation Day prevented the use of telephoto lenses and thus it was only possible to get a fleeting glance of Their Majesties by the near camera.

The original intention, I understand, was that had it been possible to use the telephoto lenses the King's head would have been held in the picture as a close-up for as long as 15 to 30 seconds. Even so, the view obtained was splendid and the details seen quite astonishing: it must now be quite obvious to every close observer that the E.M.I. camera is more sensitive than the human eye.

* * *

Freddie Grisewood, who did the commentary, has not been definitely transferred to the Television Depart-

ment as was stated in some of the daily newspapers. He was used for this Coronation broadcast as for some others, and will, I understand, be loaned on other special occasions, but in the meantime continues his principal work as announcer in the sound programmes. When the rehearsals were being held for the Coronation broadcast it was clearly evident that a commentator in television needs to talk in rather a different way from that usually employed in sound broadcasting. To begin with, Mr. Grisewood described far too much, just as if he were doing ordinary announcing, because in sound broadcasting obviously the announcer must describe everything as the listeners can see nothing. I

Pringle's old music-hall show on Coronation night, which was a great success. Albert Whelan, the well-known Australian entertainer, came on and as usual shed his gloves, hat and overcoat to the accompaniment of his well-known signature tune; while Arthur Prince and Jim was another familiar turn which came over extremely well.

Harry Pringle deserves especial congratulation on this show, for he certainly managed to invest the whole affair with the veritable atmosphere of the old music-hall. I understand that in the studio itself a wonderful transformation was effected, the place really being turned into a miniature old music-hall complete with boxes at the side, while the cameras

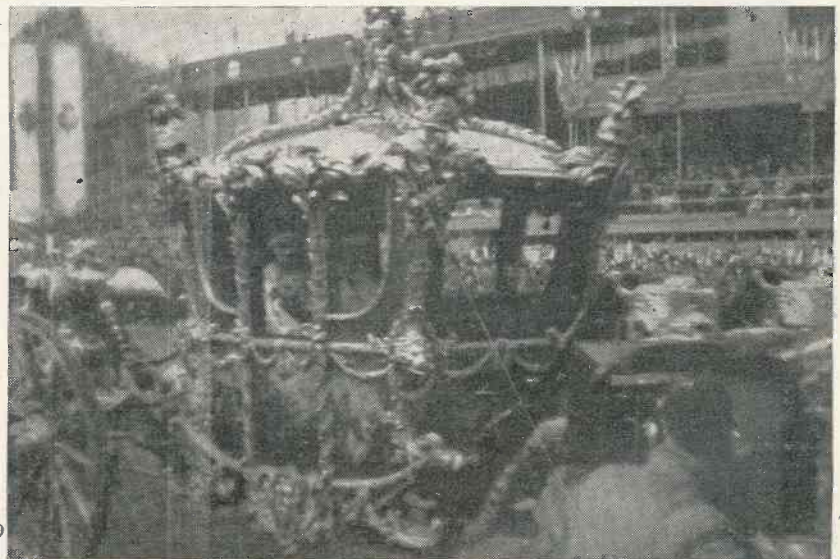

Televising their Majesties at Apsley Gate, Hyde Park Corner. This exclusive picture, taken at the spot, shows the television camera on the right. The operator is wearing headphones through which he received instructions from the control point in the mobile television unit situated behind the Park Keeper's Lodge, 100 yards distant.

believe this was pointed out to him, and he soon realised that in this new sphere listeners had eyes, so that when it came to the actual broadcast on Coronation Day he put up a remarkably good show, not saying too much and yet adding to the screen view just those vivid touches of description which were necessary.

* * *

Of the other Coronation broadcasts I must not forget Harry

themselves were very ingeniously placed.

* * *

There have been few changes of any importance at Alexandra Palace during the month, but interesting experiments in studio technique continue to be made. Mr. George More O'Ferrall has been responsible for some of these. As readers will remember, he went to Alexandra Palace as an assistant producer, but

PROGRAMME HIGH-LIGHTS

was promoted to the rank of producer within six weeks, and he seems to have a distinct future in this type of work.

One of the most interesting cases occurred in the broadcasting of "Twelfth Night" in which Miss Greer Garson, the brilliant young actress, appeared both as Sebastian and Viola. The figures of both were seen on the screen at the same time,



Elinor Shan who gave an original dancing display to televisioners.

one being a full face view and the other a back view, and you may wonder how simultaneous photographs of the same person were possible, but I am assured that a tiny mirror in front of the lens was the complete explanation.



Greer Garson, who took the part of Lady Teazle in scenes from "The School for Scandal" in the recent television transmission.

Then again, in the broadcast of "Alice in Wonderland," also produced by Mr. O'Ferrall, a most intriguing piece of realism was introduced when Alice drank the potion which makes her grow smaller and smaller. This miraculous shrinkage actually took place before the eyes of

astonished lookers, the effect being produced by having one camera tracking up to the table while another was retreating.

Mr. O'Ferrall is very go ahead and ready to experiment, and in this respect I suppose is only excelled by Mr. D. H. Munro, the popular productions manager, who is the studio technique experimenter par excellence. I hear that Mr. Munro frequently works half through the night perfecting the details of his new shows, and certainly a great deal of the success of television up-to-date must be attributed to his indefatigable hard work.

As mentioned last month, Mr. Munro is now doing a good deal of production himself. One of his shows last month was "Les Patineurs," which was the most notable ballet show of the month. Mr. Stephen Thomas usually deals with ballet programmes, and I dare say it was because he was otherwise engaged that Mr. Munro took this show over. In "Les Patineurs" a white rubber floor was used, and it is interesting to note that this original rubber stuff is the same as was used in the old 30-line transmissions.

* * *

Another programme of interest to balletomanes was the appearance of Anton Dolin and Markova, but this happened to occur on Coronation eve and was not a very convenient day for many people to look-in. For this reason I personally missed it, although I had seen their show at the Kings, Hammersmith, during the same week.

Television now seems to be attracting many big artists. Among the many outstanding people who have made their bow to the television camera this month is Gracie Fields, the inimitable Lancashire comedienne. Franz Lehár was to have been guest conductor of the television orchestra on May 27, but unfortunately was unable to appear.

Gracie Fields' appearance in television was memorable at the Palace for another reason in addition to the excellence of her show: no fewer than 9,000 people came to Alexandra Palace from Rochdale, Gracie's native town. In fact, Ally Pally went all Rochdale!

A new trend in the television programmes was observed when "On Your Toes" from the Coliseum was

televised during the month. This again was one of Mr. D. H. Munro's brilliant productions, and was a whole hour presentation featuring all the principal stars from the Coliseum show, including the dynamic Eddie



Here is Joan Miller, the television Picture Page Girl.

Pola. Hitherto, the television broadcasts have always been composite in nature, and this programme must have caused many viewers to ask themselves whether they would prefer one continuous show of this sort, or



Joan Collier, who was seen and heard as Polly Peachum in the television production of "The Beggar's Opera" at Alexandra Palace.

the more usual collection of interesting snippets.

* * *

I hear that the B.B.C.'s television special demonstration film will be broadcast early in June, and that the time selected is 12.30 p.m. to 1.30 p.m. This film will run for about 40 minutes, but it should be pointed out that it is intended solely for the use of shops, dealers and demonstration rooms, and not for ordinary viewers. An ordinary viewer, of course, would soon become tired of the repetition; and apart from that, I think the B.B.C. itself realises that film is not

(Continued in 3rd col. of next page).

THE NEW VISION

SOME CONSIDERATIONS OF EYE STRAIN IN VIEWING

BY A FELLOW OF THE BRITISH OPTICAL ASSOCIATION

THE developments in any new form of vision are subjects for serious study to an ophthalmic optician. As a keen radio constructor, it is natural for television to attract one's attention. The combination of the two viewpoints tend to make one intensely interested in this new vision.

The chief practical objections to television made by viewers appear to be (a) the smallness of the picture, and (b) a somewhat nebulous type of eyestrain experienced after a short session of viewing.

I venture to suggest that these faults, if they can be so called, have a common optical link in the physical mechanism of the human eye.

Certain muscles are called into play when the eyes are focused on any object. The closer the object, the greater muscular effort will be required to focus it.

Relative Sizes

The eyes have also become accustomed to the relative sizes of standard objects. For instance, a man seen at a distance of twenty feet will appear to be of a certain size or, in geometric language, he will subtend a certain angle. A difference of a few inches in height between two men will not greatly affect the subtended angle. As the man approaches the observer, the angle will increase.

The human eye automatically links up the normal size of objects with the distance from which they are seen and it is apparent, therefore, that any violent change in this long-established co-operation between muscle energy and distance perception will create a feeling of strangeness. It has been observed that with larger screens, even though the picture quality is inferior, there is less strain on the eye than with a small screen.

Owing to the small size of the screen used in television, the eyes are forced to accept the image of a man which, according to its size should be about thirty feet distant, but which is only, say, three feet away. No adjustment of distance from the screen will compensate for the mechanical smallness of the image, so

the eyes are forced to exert energy to focus the screen to see an image which, according to its size, should not need this energy to focus it.

The link between size and distance at the cinema cannot be compared to that when watching television, as it is seldom that pictures are seen which destroy this peculiar optical coupling. The greater distance from the screen allows more latitude in the sizes of images projected. The same strange feeling is experienced, however, when there is a long period of close-up photography, the image then being far larger than the eyes expect it to be at a definite distance from the screen. Fortunately, very few "close-ups" last for more than thirty seconds.

The radio picture is acknowledged to be more prone to blurring than the projected cinema film. Any diffused image creates a strain on the eyes owing to their natural desire to see a clear picture. Eyes seeing a blurred image will try, by using their own muscles, to sharpen the focus. In the case of a blurred picture, no improvement can be made by muscular effort and the eyes have to receive the image in an unnatural state which they do under protest.

Sound and Vision

There is also the possibility that the faulty relation between the image size and the volume of sound emitted, presumably by that image, has an adverse effect.

The brain has been accustomed to the volume of a man's voice being produced by a full-sized man. The cinema is able to provide some regulation to retain this normal coupling, but television, as I have seen it, completely upsets one's conception of vision-sound relationship. The increase in volume needed when a "close-up" is transmitted should, of course, be provided at the transmitting end and does not appear difficult to arrange.

The faulty relation between size and sound should not produce any adverse physical effects, but the size and distance factor is bound to create a somewhat unusual feeling until one

has become thoroughly accustomed to it.

There is no harm in training the eyes in this new science. Those who normally wear glasses constantly and who are over fifty years of age may find it an advantage to use a special power of lens for seeing television.

"Studio and Screen"

(Continued from preceding page)

equal in technical excellence to the live programmes usually transmitted from the Palace.

The purpose of the film is to indicate the type and scope of television programmes and to give a representative idea to a prospective buyer of a set of the sort of material he can expect to see. In other words, this recorded programme shows the highlights of television up-to-date, and includes George Robey, Hore Belisha, the Television Orchestra, announcers, the "Zoo-Man," dance band interludes, and so on. It is an excellent idea, and should be a great help to the trade.

And writing about the trade reminds me to mention that the wireless exhibition this year may well be "Teleolympia" instead of "Radiolympia," for the B.B.C., I hear, is planning unique demonstrations which should be staggeringly impressive.

A New Valve for the Higher Frequencies

A new valve that is fast becoming a "standard" for high-frequency work is the Taylor T-55, a carbon anode triode with a ceramic base and mount. Although rated to have an anode dissipation of 55 watts, a pair in push-pull at 5-metres will give over 300 watts as class "C" amplifiers.

The following characteristics will give some idea of the performance.

Max. anode volts unmodulated D.C., 1,500 v.

Max. anode volts modulated D.C., 1,500 v.

Max. D.C. plate current, 150 M/a.

Max. D. C. grid current, 40 M/a.

Max R.F. grid current, 5 amps.

R.F. output, 168 watts.

This valve can be obtained from G₂NO, Eves Radio, Ltd., 11 Litchfield Street, Wolverhampton. Deliveries are from stock. The price is 45s.

A Cathode-ray Tuning Indicator

Constructors will find that the cathode-ray tuner described is ideal for use in short-wave receivers. It has many other uses and can be used for measurement of modulation percentage if a calibrated scale is drawn to suit the particular instrument in which the tuner is being used.

CONSTRUCTORS who wish to embody in their receiver a sensitive tuning indicator such as is seen on most American all-wavers, should give serious consideration to the new Mazda valve type AC/ME, which is virtually a miniature cathode-ray tube.

In the past most visual tuning indicators, while being satisfactory on strong stations, have not proved efficient on short waves, owing to the comparatively small field strengths.

The AC/ME tuning indicator consists basically of a hot cathode acting as a source of electrons which are attracted to a positively charged target coated with a fluorescent substance. Electrons impinging on the coated target cause it to glow and the extent of the fluorescent area is controlled by means of a cathode-ray electrode placed between the cathode and the target.

When the potential of the ray control electrode is increased from a low positive potential to a high positive potential, the area of shadow produced on the target is reduced.



The AC/ME cathode-ray tuning indicator is fitted with a 7-pin base and designed for horizontal mounting.

The ray control electrode is connected internally to the anode of the triode, and in use a high resistance is placed in the triode-anode circuit so that it operates as a resistance-coupled D.C. amplifier.

Owing to its high sensitivity it is one of the most reliable tuning indicators available, with perhaps as the one exception, the low reading micro-amp. meter. Signals with a field strength of R5 or more make a very big difference to the amount of shadow, which means that most readable signals can be tuned in by means of this indicator. This is a great advantage over the neon gas type of tuner, which was only suitable for measurement of strong signals.

The AC/ME tuner is similar in appearance to the conventional valve, being fitted with a 7-pin base and arranged so that it is mounted horizontally in the receiver.

The control grid of the AC/ME should always be controlled from the detector-diode circuit and not from the A.V.C. diode circuit, so as to enable visual tuning to be obtained below the delay point.

D.C. voltages applied to the grid will have to be applied via a tapped resistance so that the correct voltage can be obtained experimentally.

The heater of the AC/ME is designed to operate from a 4-volt A.C. supply and the transformer should be designed to supply this voltage under full load.

"A SELF-CONTAINED THREE VALVE RECEIVER"

DESCRIBED IN
THIS ISSUE—

Also—metal work for "A 2-watt Twin Pentode Receiver for 7 metres" and "An A.C., D.C., E.C.O. Unit."

Useful list of stock metal parts and aids to construction free on request.

CABINET
PANEL
SCREEN
CHASSIS

by

for
**ANYTHING
IN
METAL**

Write or
'Phone:



METALWORKS
171c, Battersea Park Road,
London - - - S.W.8

MACAULAY 4840

TELEVISION

We stock the Baird Televisor at 55 guineas, and the Cossor at 70 guineas, and offer Easiest of Easy Terms, and part exchanges for modern radio equipment.

AMATEUR COMMUNICATIONS

We specialise in all requirements of the Radio Amateur, including modern communication receivers, such as National, Hallicrafters, Hammarlund, etc., and a comprehensive range of components, valves, microphones, etc., including the complete Eddystone range. We offer a completely constructed range of Transmitters from £10 - 10.0, with a guaranteed performance, or can build any equipment to special order, or supply any desired kits, at competitive prices. Why not let us quote you without obligation?

A.C.S. Ltd. G2NK,

52/4, Widmore Road, Bromley, Kent. Technical Manager.
Phone: Ravensbourne 0156/7.

AMBITIOUS MEN

To ensure promotion take advantage of The T.I.G.B.'s authoritative home-study courses in **Television, Sound Recording, Radio Engineering & Servicing, Wireless Communications, etc.** Write TO-DAY for "The Engineer's Guide to Success"—Free—which gives full particulars—contains the world's widest choice of engineering courses covering all branches—and alone gives the Regulations for Qualifications such as **A.M.I.E.E., A.M.I.R.E., A.M.I.T.E., A.M.I.W.T., C. & G.,** etc. Training until successful Guaranteed.
The Technological Institute of Great Britain,
160, Temple Bar House, London
E.C.4.
(Founded 1917. 20,000 Successes.)



**JANETTE CONVERTERS
AND
PETROL ELECTRIC GENERATING PLANTS**

The generating plants are available with AC or DC outputs, suitable for operating amplifiers, radios, etc., whilst they have undoubted advantages over a rotary converter and batteries, where a large output is required for PA work.



The JANETTE ROTARY CONVERTER

These machines are in use throughout the world, and possess an unrivalled reputation for reliability and efficiency. We have practically every normal type in stock, with inputs from 32 volts upwards. They are available with all-wave filter, suitable for operating a radio receiver from 5 metres upwards.

Sole Distributor:

CHAS. F. WARD 46, Farringdon St. LONDON, E.C.4
Tel: Holborn 9703.



**PIEZO QUARTZ
CRYSTALS**

1.7 mc., 3.5 mc., and 7.0 mc.,
Amateur Bands.

**OUR NEW
CATALOGUE**
of Short-wave
components. 24
pages fully illus-
trated. 1½d.
post free.

Power Type Standard Type
20/- post free. 15/- post free

CRYSTAL HOLDERS:—

Type A, Open Electrodes
4s. 6d. post free.

Type B, Totally enclosed and
dustproof, 8s. 6d. post free.

THE QUARTZ CRYSTAL CO., LTD.
63 & 71, Kingston Road, New Malden, Surrey
Telephone: MALDEN 0334.

FOYLES

BOOKSELLERS TO THE WORLD
Stock of nearly three million new and second-
hand volumes. Catalogues free on mentioning
your interests.

119-125 Charing Cross Rd., London, W.C.2.
Telephones: Gerrard 5660 (12 lines)

REDUCTION IN PRICE OF APPARATUS

We offer "MERYVN" UNITS IN KIT FORM

TIME BASE KIT LESS VALVES £3-5-0
POWER PACK KIT LESS VALVES £6-0-0
EXCITER UNIT AND CONTROL PANEL
for 4,000 VOLTS. KIT LESS VALVE £5-0-0
I.F. TRANSFORMERS SPECIALLY
CONSTRUCTED for VISION RECEIVER, PRICE 6/-each
SEND for NEW PRICES

H. E. SANDERS & CO., 4, Gray's Inn Road,
LONDON, W.C.1. Tele: Chancery 8778.

**MISCELLANEOUS
ADVERTISEMENTS**

The charge for advertisements in these columns is 12 words or less 2/-, and 1d. for every additional word. All advertisements must be accompanied by remittance. Cheques and Postal Orders should be made payable to Bernard Jones Publications Ltd., and crossed, and should reach this office not later than the 15th of the month previous to date of issue.

GUARANTEED TELEVISION PARTS as specified, all new, half price, Box 11.

INDEX TO ADVERTISERS

A.C.S., Ltd.	382
Alert Radio Co.	Cover iii
A.P.A. Metalworks	382
Baird Television, Ltd.	333
Belling & Lee, Ltd.	Cover ii
British Institute of Engineering Technology	Cover iii
British Mechanical Productions, Ltd.	321
Bulgin, A. F. & Co., Ltd.	380
Chapman and Hall	379
Clix	321
Cossor, A. C., Ltd.	Cover iv
Dubilier Condenser (1925), Ltd.	375
Ericsson Telephones, Ltd.	381
Edison Swan Electric Co., Ltd.	322
Eves Radio, Ltd.	377
Fluxite, Ltd.	Cover ii
Foyles'	Cover iii
G5KA	Cover iii
Galpin's	383
High Vacuum Valve Co., Ltd.	381
Henley's, W. T., Telegraph Works Co., Ltd.	Cover ii
Marconi's Wireless Telegraph Co., Ltd.	321
McGraw-Hill Publishing Co.	377
Mullard Wireless Service Co., Ltd.	334
Premier Supply Stores	373
Quartz Crystal Co., Ltd.	Cover iii
Radio Resistor Co., Ltd.	321
Radio Society of Great Britain	384
362 Radio Valve Co., Ltd.	375
Raymart Manufacturing Co.	380
Sanders, H. E., & Co.	Cover iii
Sound Sales, Ltd.	321
Stratton & Co., Ltd.	381
Technological Society of Gt. Britain	382
Television Society, The	384
Ward, Chas. F.	Cover iii
Westinghouse Brake & Signal Co., Ltd.	379

MEASURING INSTRUMENTS ON LOAN. In response to numerous requests we would remind experimenters of our Loan Service of Measuring Instruments such as Wheatstone Bridges, Meggers, Standard Resistances, Sub-standard Condensers etc., at very low rates. Send us your requirements: H. E. Sanders & Co., 4, Grays Inn Road, London, W.C.1. 'Phone: Chancery, 8778.

ROTARY CONVERTOR, M.L. 200-220 volts D.C. to 230 volts A.C. 50 Cycles. Output 85 watts. Complete with smoothing unit, £3. Box X154.

TELEVISION; limited number Ediswan 10 in cathode ray tubes, used for demonstrations, excellent condition; £5 each. Furzehill Laboratories, Boreham Wood.

**PATENT AND TRADE
MARK AGENTS**

GEE & CO. (Estab. 1905), patents and trade marks throughout the world (H. T. P. Gee, Mem. R.S.G.B., A.M.I.R.E., etc.), 51-52, Chancery Lane, London, W.C.2 (2 doors from Government Patent Office.) 'Phone: Holborn 4547 (2 lines). Handbook free.

KINGS PATENT AGENCY LTD. (B. T. King, Patent Agent) 146a, Queen Victoria Street, London, E.C.4. **ADVICE, Handbook and Consultations free** Phone City 6161.

**COMMUNICATION RECEIVERS
1937 MODELS**

COMPLETE HALLICRAFTER RANGE
NATIONAL NC 100 X R.M.E. 69 etc.
LATEST PATTERSON MODEL - JUST
RELEASED. P.R.15. 15 VALVES.

Let us have your enquiries.

ALERT RADIO CO.

21 East Rd., London, N.1 Phone Clerkenwell 4871

TELEVISION.

A NEW COURSE OF INSTRUCTION,

We have pleasure in announcing that our new "Television" Course has met with remarkable success. The enormous demand for the Course has shown, beyond any shadow of doubt, that it fills that long-felt need which we anticipated when we went to such trouble and expense in its preparation.

We shall be happy to send full details of this special "Television" Course on request. Particulars are also available of other Courses in all branches of Wireless, Television, Talking Picture Engineering, etc., and of the easiest way in which to prepare for the A.M.I.E.E., A.M.I.W.T., A.M.I.R.E., etc., Examinations.

We teach by correspondence, and guarantee "NO PASS—NO FEE." Our Technical Consultant is Professor A. M. Low.

Send for full particulars to-day. Free and without obligation.

THE BRITISH INSTITUTE OF ENGINEERING TECHNOLOGY
337, SHAKESPEARE HOUSE, 17/19, STRATFORD PLACE,
LONDON, W.1.

AMATEUR RADIOTELEPHONY.

s. d.

Latest work by Frank Jones (Author of Jones Radio Handbook)	3 3
Radio Amateur Newcomer	1 0
Jones Radio Handbook (You can't afford to be without this one)	6 6
"Antenna Handbooks." Full of hot dope on antennas that bring results	2 6
Radio Maps of the World (A.R.R.L.)	5 0
Log Books (A.R.R.L.)	1 8
Hints and Kinks (A.R.R.L.) This book is a time and money saver	2 6

All the above post free.

G5KA, 41, Kinfauns Road, Goodmayes, Essex.
Dept. "T."



*from the most
comprehensive range
of*

CATHODE RAY TUBES

Since 1902 Cossor research in the design and practice of Cathode Ray Tubes has always kept ahead of the times. As a result to-day Cossor have available a comprehensive range of Cathode Ray Tubes second-to-none.

Cossor research in the field of Television too, has proved eminently fruitful, and results have amply justified their pioneer work in the use of Cathode Ray Tubes for Television. Progress in this sphere has brought about many types but the Cossor full range of tubes is admitted as being unparalleled in respect of quality, focus and brilliance.

A request for leaflet L.213 to Instrument Dept., A. C. Cossor Ltd., Highbury Grove, London, N.5, will bring full details and data of the range available.

from the
'WIRELESS WORLD'
Editorial 2.4.37.

“It was not until about thirty years later that the cathode-ray tube came to be regarded as an every-day instrument in the laboratory, although as long ago as 1902 Cossors, the valve manufacturers, were producing their first examples.”

COSSOR

CATHODE RAY TUBES

A. C. COSSOR LTD., HIGHBURY GROVE, LONDON, N.5

Ⓜ 1731